

PRODOTTI INAR-LOCK PER CONNESSIONI MULTIPLE
INAR-LOCK PRODUCTS FOR MULTI-WAY CONNECTIONS
INAR-LOCK PRODUKTE FÜR VIELFACHANSCHLÜSSE
PRODUITS INAR-LOCK POUR CONNEXIONS MULTIPLES

TERMINALI INAR-LOCK UNIVERSAL	CONTACTS INAR-LOCK UNIVERSAL	KONTAKTE INAR-LOCK UNIVERSAL	CONTACTS INAR-LOCK UNIVERSAL	10.6
CONNETTORI INAR-LOCK UNIVERSAL	HOUSINGS INAR-LOCK UNIVERSAL	GEHÄUSE INAR-LOCK UNIVERSAL	BOITIERS INAR-LOCK UNIVERSAL	10.11
CONNETTORI INAR-LOCK UNIVERSAL PER MOTORI	HOUSINGS INAR-LOCK UNIVERSAL FOR MOTORS	GEHÄUSE INAR-LOCK UNIVERSAL FÜR MOTOR	BOITIERS INAR-LOCK UNIVERSAL POUR MOTEURS	10.21
SCATOLETTE SERRACAVO UNIVERSAL	STRAIN RELIEF (ENCLOSED VERSION) UNIVERSAL	ZUGENTLASTUNG (GESCHLOSSENE AUSFÜHRUNG) UNIVERSAL	BOITIERE FERME-FILS UNIVERSAL	10.23
CONNETTORI INAR-LOCK C.S.	CONNECTORS INAR-LOCK C.S.	VERBINDER INAR-LOCK C.S.	BOITIERS INAR-LOCK C.S.	10.25
TERMINALI INAR-LOCK STANDARD	CONTACTS INAR-LOCK STANDARD	KONTAKTE INAR-LOCK STANDARD	CONTACTS INAR-LOCK STANDARD	10.37
CONNETTORI INAR-LOCK STANDARD	HOUSINGS INAR-LOCK STANDARD	GEHÄUSE INAR-LOCK STANDARD	BOITIERS INAR-LOCK STANDARD	10.38
TERMINALI INAR-LOCK GIANT	CONTACTS INAR-LOCK GIANT	KONTAKTE INAR-LOCK GIANT	CONTACTS INAR-LOCK GIANT	10.47

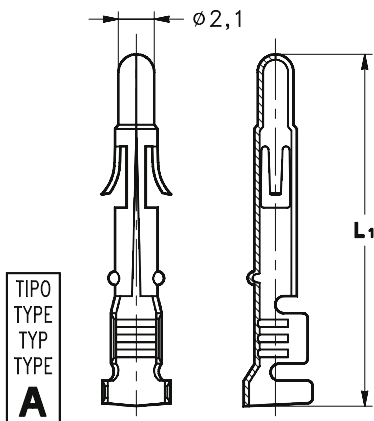

TERMINALI MASCHIO UNIVERSAL

UNIVERSAL PIN CONTACTS

UNIVERSAL STIFT KONTAKTE

CONTACTS BROCHE UNIVERSAL

Tab. n° 1

Tipo Type Typ Type	Sezione cavo Wire range Nennquerschnitt Section cable	ø Isolante ø Insulation ø Isolation ø Gaine	L1	Codice Nr. P. N. Art. Nr. Code Nr.	Materiale Material Werkstoff Matiere	Confezione Packing Verpackung Conditionnement
A	0,25 ÷ 0,75	1,5 ÷ 2,2	20,8	0011067101	Cu Zn PRE-TIN	5000x5
				0011067501	Cu Zn gal Au	
				0111067101	Cu Sn PRE-TIN	
				0111067501	Cu Sn gal Au	
A	0,5 ÷ 2	1,9 ÷ 3,3	20,8	0010834101	Cu Zn PRE-TIN	5000x5
				0010834501	Cu Zn gal Au	
				0110834101	Cu Sn PRE-TIN	
				0110834501	Cu Sn gal Au	
A	0,5 ÷ 2	3,3 ÷ 5,1	21,1	0011063101	Cu Zn PRE-TIN	2500x5
				0011063501	Cu Zn gal Au	
				0111063101	Cu Sn PRE-TIN	
				0111063501	Cu Sn gal Au	

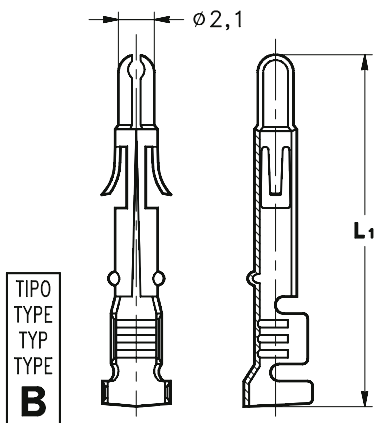

TERMINALI MASCHIO UNIVERSAL
APERTI

UNIVERSAL PIN CONTACTS
OPEN

UNIVERSAL STIFT KONTAKTE
OFFEN

CONTACTS BROCHE UNIVERSAL
OUVERT

Tab. n° 2

Tipo Type Typ Type	Sezione cavo Wire range Nennquerschnitt Section cable	Ø Isolante Ø Insulation Ø Isolation Ø Gaine	L1	Codice Nr. P. N. Art. Nr. Code Nr.	Materiale Material Werkstoff Matiere	Confezione Packing Verpackung Conditionnement	Nota Note Anmerk. Note
B	0,25 ÷ 0,75	1,5 ÷ 2,2	20,8	0011333101	Cu Zn PRE-TIN	5000x5	[i]
				0011333501	Cu Zn gal Au		
				0111333101	Cu Sn PRE-TIN		
				0111333501	Cu Sn gal Au		
B	0,5 ÷ 2	1,9 ÷ 3,3	20,8	0010934101	Cu Zn PRE-TIN	5000x5	[i]
				0010934501	Cu Zn gal Au		
				0110934101	Cu Sn PRE-TIN		
				0110934501	Cu Sn gal Au		
B	0,5 ÷ 2	3,3 ÷ 5,1	21,1	0011258101	Cu Zn PRE-TIN	2500x5	[i]
				0011258501	Cu Zn gal Au		
				0111258101	Cu Sn PRE-TIN		
				0111258501	Cu Sn gal Au		

[i]: Da preferire per connessioni oltre le 6 vie.
To be preferred for larger than 6-ways connections.
Für Anschlüsse mit mehr als 6 Wegen.
A préférer pour les connexions de plus de 6 voies.

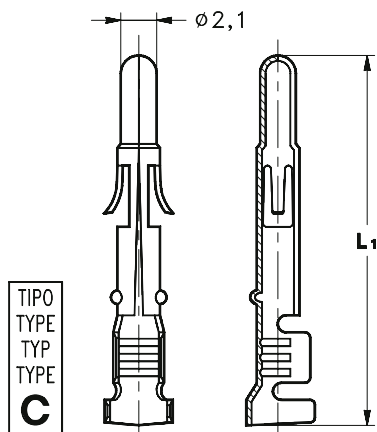

**TERMINALI MASCHIO UNIVERSAL
DI MASSA**

**UNIVERSAL PIN CONTACTS
EARTH**

**UNIVERSAL STIFT KONTAKTE
MASSE**

**CONTACTS BROCHE UNIVERSAL
DE MASSE**

Tab. n° 3

Tipo Type Typ Type	Sezione cavo Wire range Nennquerschnitt Section cable	ø Isolante ø Insulation ø Isolation ø Gaine	L1	Codice Nr. P. N. Art. Nr. Code Nr.	Materiale Material Werkstoff Matiere	Confezione Packing Verpackung Conditionnement
C	0,5 ÷ 2	1,9 ÷ 3,3	22,3	0011110101	Cu Zn PRE-TIN	5000x5
				0011110501	Cu Zn gal Au	
				0111110101	Cu Sn PRE-TIN	
				0111110501	Cu Sn gal Au	

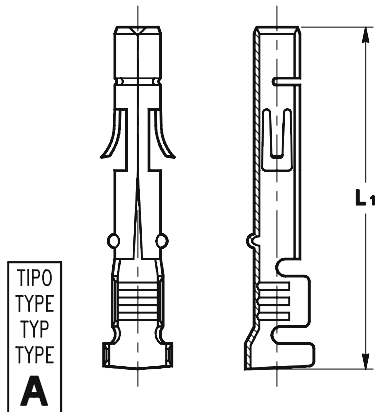

TERMINALI FEMMINA UNIVERSAL
APERTI

UNIVERSAL SOCKET CONTACTS
OPEN

UNIVERSAL BUCHSE KONTAKTE
OFFEN

CONTACTS DOUILLE UNIVERSAL
OUVERT

Tab. n° 4

Tipo Type Typ Type	Sezione cavo Wire range Nennquerschnitt Section cable	Ø Isolante Ø Insulation Ø Isolation Ø Gaine	L1	Cilindrico Cylindrical Rund Cylindrique	Codice Nr. P. N. Art. Nr. Code Nr.	Materiale Material Werkstoff Matiere	Confezione Packing Verpackung Conditionnement
A	0,25 ÷ 0,75	1,5 ÷ 2,2	20,1		0011060101	Cu Zn PRE-TIN	5000x5
					0011060501	Cu Zn gal Au	
					0111060101	Cu Sn PRE-TIN	
					0111060501	Cu Sn gal Au	
A	0,5 ÷ 2	1,9 ÷ 3,3	20,1		0010935101	Cu Zn PRE-TIN	5000x5
					0010935501	Cu Zn gal Au	
					0110935101	Cu Sn PRE-TIN	
					0110935501	Cu Sn gal Au	
A	0,5 ÷ 2	1,9 ÷ 3,3	20,1	X	0011100101	Cu Zn PRE-TIN	5000x5
					0011100501	Cu Zn gal Au	
					0111100101	Cu Sn PRE-TIN	
					0111100501	Cu Sn gal Au	
A	0,5 ÷ 2	3,3 ÷ 5,1	20,4		0011064101	Cu Zn PRE-TIN	2500x5
					0011064501	Cu Zn gal Au	
					0111064101	Cu Sn PRE-TIN	
					0111064501	Cu Sn gal Au	

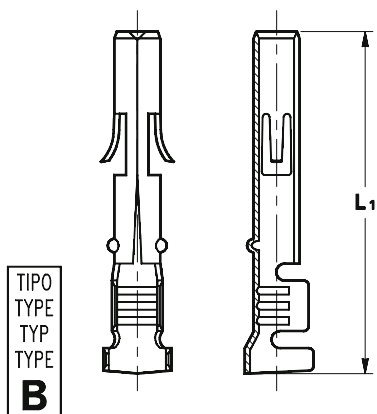

TERMINALI FEMMINA UNIVERSAL

UNIVERSAL SOCKET CONTACTS

UNIVERSAL BUCHSE KONTAKTE

CONTACTS DOUILLE UNIVERSAL

Tab. n° 5

Tipo Type Typ Type	Sezione cavo Wire range Nennquerschnitt Section cable	Ø Isolante Ø Insulation Ø Isolation Ø Gaine	L1	Codice Nr. P. N. Art. Nr. Code Nr.	Materiale Material Werkstoff Matiere	Confezione Packing Verpackung Conditionnement
B	0,5 ÷ 2	1,9 ÷ 3,3	20,1	0010855101	Cu Zn PRE-TIN	5000x5
				0010855501	Cu Zn gal Au	
				0110855101	Cu Sn PRE-TIN	
				0110855501	Cu Sn gal Au	

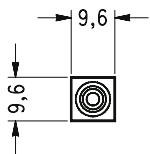

CONNETTORI FEMMINA UNIVERSAL 1 VIA

CAP HOUSINGS UNIVERSAL 1 WAY

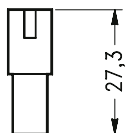

AUFNAHMEGEHÄUSE UNIVERSAL 1 POLIG

BOITIERS FEMELLE UNIVERSAL 1 VOIE

Tab. n° 6

Nr. vie Ways No. Polzahl N. Voies	Codice Nr. P. N. Art. Nr. Code Nr.	Materiale Material Werkstoff Matiere	Confezione Packing Verpackung Conditionnement
1	0854051700	PA 66 V-2	10000
	0855051700	PA 66 V-0	
051700	Glow Wire 750° no flame	

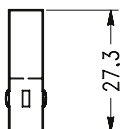

CONNETTORI MASCHIO UNIVERSAL 1 VIA

PLUG HOUSINGS UNIVERSAL 1 WAY

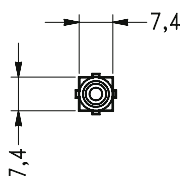

STECKERGEHÄUSE UNIVERSAL 1 POLIG

BOITIERS MALE UNIVERSAL 1 VOIE

Tab. n° 7

Nr. vie Ways No. Polzahl N. Voies	Codice Nr. P. N. Art. Nr. Code Nr.	Materiale Material Werkstoff Matiere	Confezione Packing Verpackung Conditionnement
1	0854050700	PA 66 V-2	10000
	0855050700	PA 66 V-0	
050700	Glow Wire 750° no flame	

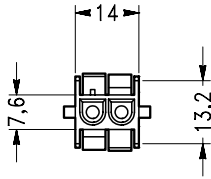

CONNETTORI FEMMINA UNIVERSAL 2 VIE

CAP HOUSINGS UNIVERSAL 2 WAYS

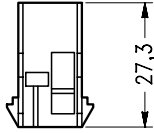

AUFNAHMEGEHÄUSE UNIVERSAL 2-POLIG

BOITIERS FEMELLE UNIVERSAL 2 VOIES

Tab. n° 8

Nr. vie Ways No. Polzahl N. Voies	Codice Nr. P. N. Art. Nr. Code Nr.	Materiale Material Werkstoff Matiere	Confezione Packing Verpackung Conditionnement	Nota Note Anmerk. Note
2	0854053700	PA 66 V-2	5000	
	0855053700	PA 66 V-0		
	...053700	Glow Wire 750° no flame		
2	5450372700	PA 66 V-2	5000	[]
	5550372700	PA 66 V-0		
	..50372700	Glow Wire 750° no flame		

[]: Per dima speciale./Special template./Spezielschablone./Gabarit spécial.

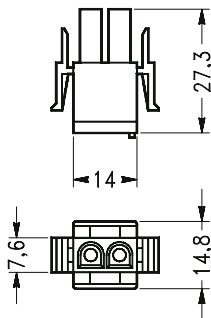

CONNETTORI MASCHIO UNIVERSAL 2 VIE

PLUG HOUSINGS UNIVERSAL 2 WAYS

STECKERGEHÄUSE UNIVERSAL 2-POLIG

BOITIERS MALE UNIVERSAL 2 VOIES

Tab. n° 9

Nr. vie Ways No. Polzahl N. Voies	Codice Nr. P. N. Art. Nr. Code Nr.	Materiale Material Werkstoff Matiere	Confezione Packing Verpackung Conditionnement
2	0854052700	PA 66 V-2	5000
	0855052700	PA 66 V-0	
	...052700	Glow Wire 750° no flame	

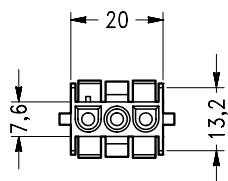

CONNETTORI FEMMINA UNIVERSAL 3 VIE

CAP HOUSINGS UNIVERSAL 3 WAYS

AUFNAHMEGEHÄUSE UNIVERSAL 3-POLIG

BOITIERS FEMELLE UNIVERSAL 3 VOIES

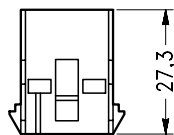

Tab. n° 10

Nr. vie Ways No. Polzahl N. Voies	Codice Nr. P. N. Art. Nr. Code Nr.	Materiale Material Werkstoff Matiere	Confezione Packing Verpackung Conditionnement
3	0854055700	PA 66 V-2	5000
	0855055700	PA 66 V-0	
	...055700	Glow Wire 750° no flame	

10

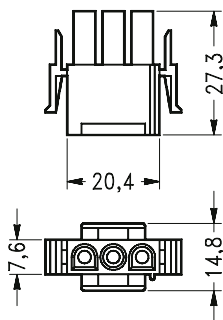

CONNETTORI MASCHIO UNIVERSAL 3 VIE

PLUG HOUSINGS UNIVERSAL 3 WAYS

STECKERGEHÄUSE UNIVERSAL 3-POLIG

BOITIERS MALE UNIVERSAL 3 VOIES

Tab. n° 11

Nr. vie Ways No. Polzahl N. Voies	Codice Nr. P. N. Art. Nr. Code Nr.	Materiale Material Werkstoff Matiere	Confezione Packing Verpackung Conditionnement	Nota Note Anmerk. Note
3	0854054700	PA 66 V-2	5000	
	0855054700	PA 66 V-0		
	...054700	Glow Wire 750° no flame		
3	5450397700	PA 66 V-2	5000	[m]
	5550397700	PA 66 V-0		
	..50397700	Glow Wire 750° no flame		

[m]: Senza agganci./Without hooks./Ohne kupplung./Sans accrochage.

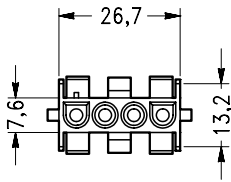

CONNETTORI FEMMINA UNIVERSAL 4 VIE

CAP HOUSINGS UNIVERSAL 4 WAYS

AUFNAHMEGEHÄUSE UNIVERSAL 4-POLIG

BOITIERS FEMELLE UNIVERSAL 4 VOIES

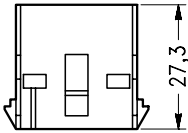

Tab. n° 12

Nr. vie Ways No. Polzahl N. Voies	Codice Nr. P. N. Art. Nr. Code Nr.	Materiale Material Werkstoff Matiere	Confezione Packing Verpackung Conditionnement
4	0854057700	PA 66 V-2	4000
	0855057700	PA 66 V-0	
057700	Glow Wire 750° no flame	

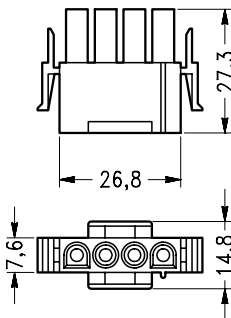

CONNETTORI MASCHIO UNIVERSAL 4 VIE

PLUG HOUSINGS UNIVERSAL 4 WAYS

STECKERGEHÄUSE UNIVERSAL 4-POLIG

BOITIERS MALE UNIVERSAL 4 VOIES

Tab. n° 13

Nr. vie Ways No. Polzahl N. Voies	Codice Nr. P. N. Art. Nr. Code Nr.	Materiale Material Werkstoff Matiere	Confezione Packing Verpackung Conditionnement
4	0854056700	PA 66 V-2	4000
	0855056700	PA 66 V-0	
056700	Glow Wire 750° no flame	

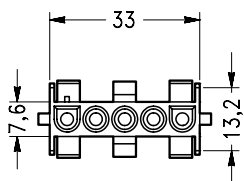

CONNETTORI FEMMINA UNIVERSAL 5 VIE

CAP HOUSINGS UNIVERSAL 5 WAYS

AUFNAHMEGEHÄUSE UNIVERSAL 5-POLIG

BOITIERS FEMELLE UNIVERSAL 5 VOIES

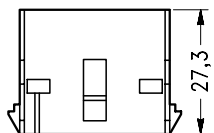

Tab. n° 14

Nr. vie Ways No. Polzahl N. Voies	Codice Nr. P. N. Art. Nr. Code Nr.	Materiale Material Werkstoff Matiere	Confezione Packing Verpackung Conditionnement
5	0854059700	PA 66 V-2	3000
	0855059700	PA 66 V-0	
059700	Glow Wire 750° no flame	

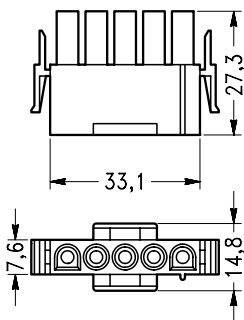

CONNETTORI MASCHIO UNIVERSAL 5 VIE

PLUG HOUSINGS UNIVERSAL 5 WAYS

STECKERGEHÄUSE UNIVERSAL 5-POLIG

BOITIERS MALE UNIVERSAL 5 VOIES

Tab. n° 15

Nr. vie Ways No. Polzahl N. Voies	Codice Nr. P. N. Art. Nr. Code Nr.	Materiale Material Werkstoff Matiere	Confezione Packing Verpackung Conditionnement
5	0854058700	PA 66 V-2	4000
	0855058700	PA 66 V-0	
058700	Glow Wire 750° no flame	

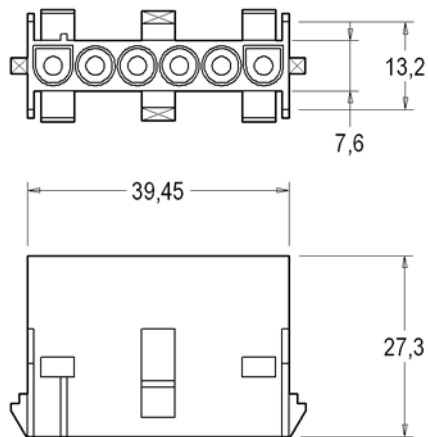

CONNETTORI FEMMINA UNIVERSAL 6 VIE

CAP HOUSINGS UNIVERSAL 6 WAYS

AUFNAHMEGEHÄUSE UNIVERSAL 6-POLIG

BOITIERS FEMELLE UNIVERSAL 6 VOIES

Tab. n° 16

Nr. vie Ways No. Polzahl N. Voies	Codice Nr. P. N. Art. Nr. Code Nr.	Materiale Material Werkstoff Matiere	Confezione Packing Verpackung Conditionnement
6	5450393700	PA 66 V-2	3000
	5550393700	PA 66 V-0	
	..50393700	Glow Wire 750° no flame	

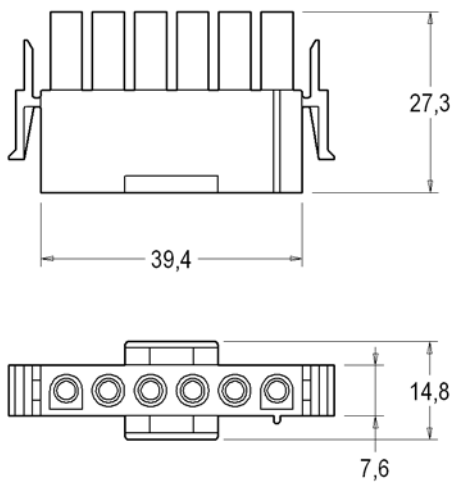

CONNETTORI MASCHIO UNIVERSAL 6 VIE

PLUG HOUSINGS UNIVERSAL 6 WAYS

STECKERGEHÄUSE UNIVERSAL 6-POLIG

BOITIERS MALE UNIVERSAL 6 VOIES

Tab. n° 17

Nr. vie Ways No. Polzahl N. Voies	Codice Nr. P. N. Art. Nr. Code Nr.	Materiale Material Werkstoff Matiere	Confezione Packing Verpackung Conditionnement	Nota Note Anmerk. Note
6	0854069700	PA 66 V-2	3000	
	0855069700	PA 66 V-0		
	...069700	Glow Wire 750° no flame		
6	5450398700	PA 66 V-2	4000	[m]
	5550398700	PA 66 V-0		
	..50398700	Glow Wire 750° no flame		

[m]: Senza agganci./Without hooks./Ohne kupplung./Sans accrochage.

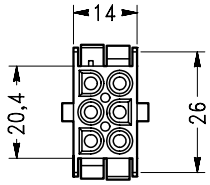

CONNETTORI FEMMINA UNIVERSAL 6 VIE

CAP HOUSINGS UNIVERSAL 6 WAYS

AUFNAHMEGEHÄUSE UNIVERSAL 6-POLIG

BOITIERS FEMELLE UNIVERSAL 6 VOIES

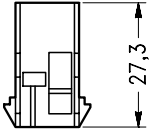

Tab. n° 18

Nr. vie Ways No. Polzahl N. Voies	Codice Nr. P. N. Art. Nr. Code Nr.	Materiale Material Werkstoff Matiere	Confezione Packing Verpackung Conditionnement
6	0854061700	PA 66 V-2	2000
	0855061700	PA 66 V-0	
061700	Glow Wire 750° no flame	

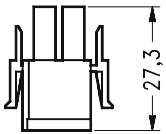

CONNETTORI MASCHIO UNIVERSAL 6 VIE

PLUG HOUSINGS UNIVERSAL 6 WAYS

STECKERGEHÄUSE UNIVERSAL 6-POLIG

BOITIERS MALE UNIVERSAL 6 VOIES

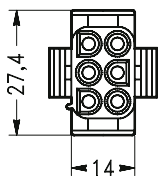

Tab. n° 19

Nr. vie Ways No. Polzahl N. Voies	Codice Nr. P. N. Art. Nr. Code Nr.	Materiale Material Werkstoff Matiere	Confezione Packing Verpackung Conditionnement
6	0854060700	PA 66 V-2	2000
	0855060700	PA 66 V-0	
060700	Glow Wire 750° no flame	

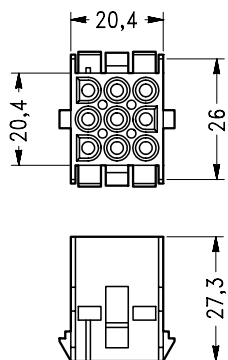

CONNETTORI FEMMINA UNIVERSAL 9 VIE

CAP HOUSINGS UNIVERSAL 9 WAYS

AUFNAHMEGEHÄUSE UNIVERSAL 9-POLIG

BOITIERS FEMELLE UNIVERSAL 9 VOIES

Tab. n°20

Nr. vie Ways No. Polzahl N. Voies	Codice Nr. P. N. Art. Nr. Code Nr.	Materiale Material Werkstoff Matiere	Confezione Packing Verpackung Conditionnement
9	0854063700	PA 66 V-2	2000
	0855063700	PA 66 V-0	
	...063700	Glow Wire 750° no flame	

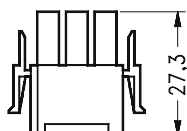

CONNETTORI MASCHIO UNIVERSAL 9 VIE

PLUG HOUSINGS UNIVERSAL 9 WAYS

STECKERGEHÄUSE UNIVERSAL 9-POLIG

BOITIERS MALE UNIVERSAL 9 VOIES

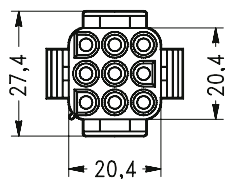

Tab. n° 21

Nr. vie Ways No. Polzahl N. Voies	Codice Nr. P. N. Art. Nr. Code Nr.	Materiale Material Werkstoff Matiere	Confezione Packing Verpackung Conditionnement
9	0854062700	PA 66 V-2	3000
	0855062700	PA 66 V-0	
	...062700	Glow Wire 750° no flame	

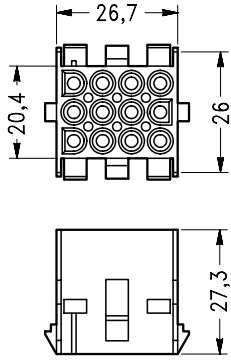

CONNETTORI FEMMINA UNIVERSAL 12 VIE

CAP HOUSINGS UNIVERSAL 12 WAYS

AUFNAHMEGEHÄUSE UNIVERSAL 12-POLIG

BOITIERS FEMELLE UNIVERSAL 12 VOIES

Tab. n°22

Nr. vie Ways No. Polzahl N. Voies	Codice Nr. P. N. Art. Nr. Code Nr.	Materiale Material Werkstoff Matiere	Confezione Packing Verpackung Conditionnement
12	0854065700	PA 66 V-2	2000
	0855065700	PA 66 V-0	
065700	Glow Wire 750° no flame	

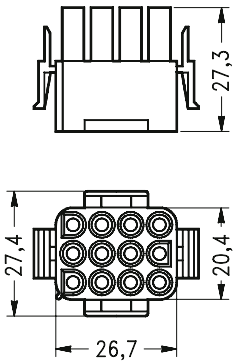

CONNETTORI MASCHIO UNIVERSAL 12 VIE

PLUG HOUSINGS UNIVERSAL 12 WAYS

STECKERGEHÄUSE UNIVERSAL 12-POLIG

BOITIERS MALE UNIVERSAL 12 VOIES

Tab. n° 23

Nr. vie Ways No. Polzahl N. Voies	Codice Nr. P. N. Art. Nr. Code Nr.	Materiale Material Werkstoff Matiere	Confezione Packing Verpackung Conditionnement
12	0854064700	PA 66 V-2	2000
	0855064700	PA 66 V-0	
064700	Glow Wire 750° no flame	

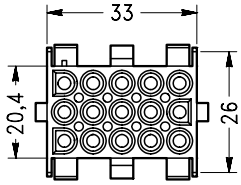

CONNETTORI FEMMINA UNIVERSAL 15 VIE

CAP HOUSINGS UNIVERSAL 15 WAYS

AUFNAHMEGEHÄUSE UNIVERSAL 15-POLIG

BOITIERS FEMELLE UNIVERSAL 15 VOIES

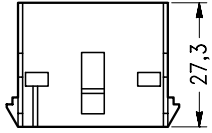

Tab. n°24

Nr. vie Ways No. Polzahl N. Voies	Codice Nr. P. N. Art. Nr. Code Nr.	Materiale Material Werkstoff Matiere	Confezione Packing Verpackung Conditionnement
15	0854067700	PA 66 V-2	1000
	0855067700	PA 66 V-0	
	...067700	Glow Wire 750° no flame	

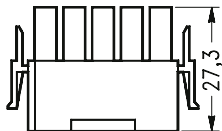

CONNETTORI MASCHIO UNIVERSAL 15 VIE

PLUG HOUSINGS UNIVERSAL 15 WAYS

STECKERGEHÄUSE UNIVERSAL 15-POLIG

BOITIERS MALE UNIVERSAL 15 VOIES

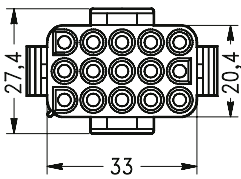

Tab. n°25

Nr. vie Ways No. Polzahl N. Voies	Codice Nr. P. N. Art. Nr. Code Nr.	Materiale Material Werkstoff Matiere	Confezione Packing Verpackung Conditionnement
15	0854066700	PA 66 V-2	2000
	0855066700	PA 66 V-0	
	...066700	Glow Wire 750° no flame	

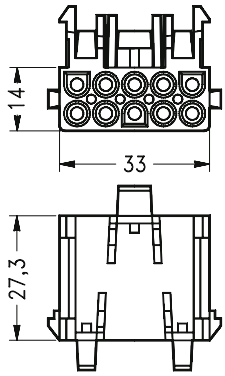

**CONNETTORI FEMMINA UNIVERSAL 10 VIE
PER MOTORI**

**CAP HOUSINGS UNIVERSAL 10 WAYS
FOR MOTORS**

**AUFNAHMEGEHÄUSE UNIVERSAL 10 POLIG
FÜR MOTOR**

**BOITIERS FEMELLE UNIVERSAL 10 VOIES
POUR MOTEURS**

Tab. n° 26

Nr. vie Ways No. Polzahl N. Voies	Codice Nr. P. N. Art. Nr. Code Nr.	Materiale Material Werkstoff Matiere	Confezione Packing Verpackung Conditionnement
10	0854079700	PA 66 V-2	1500
	0855079700	PA 66 V-0	
	...079700	Glow Wire 750° no flame	

10

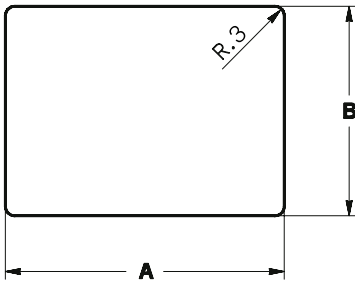

DIMA DI FORATURA

HOUSING PANEL CUTOUT

MONTAGEAUSCHNITT FÜR GEHÄUSE

DECOUPE DU PANNEAU

Nr. vie Ways No. Polzahl N. Voies	A $\pm 0,1$	B $\pm 0,1$	Spessore lamiera Plate thickness Blechdicke Epaisseur de la tole
10	30	21,8	1,4 $\pm 0,1$

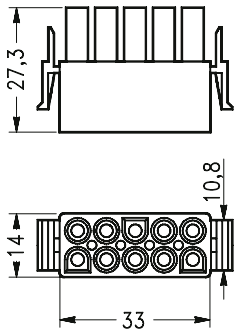

CONNETTORI MASCHIO UNIVERSAL 10 VIE
PER MOTORI

PLUG HOUSINGS UNIVERSAL 10 WAYS
FOR MOTORS

STECKERGEHÄUSE UNIVERSAL 10 POLIG
FÜR MOTOR

BOITIERS MALE UNIVERSAL 10 VOIES
POUR MOTEURS

Tab. n° 27

Nr. vie Ways No. Polzahl N. Voies	Codice Nr. P. N. Art. Nr. Code Nr.	Materiale Material Werkstoff Matiere	Confezione Packing Verpackung Conditionnement
10	0854080700	PA 66 V-2	2500
	0855080700	PA 66 V-0	
	...080700	Glow Wire 750° no flame	

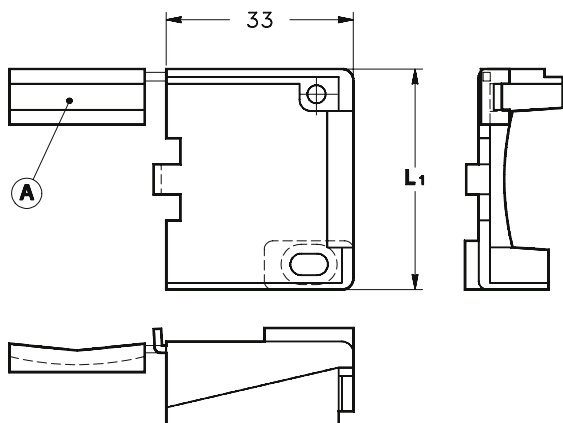

SCATOLETTE SERRACAPO

STRAIN RELIEF (ENCLOSED VERSION)

ZUGENTLASTUNG (GESCHLOSSENE AUSFÜHRUNG)

BOITIERE FERME-FILS

Tab. n° 28

Nr. vie Ways No. Polzahl N. Voies	L1	Codice Nr. P. N. Art. Nr. Code Nr.	Materiale Material Werkstoff Matiere	Confezione Packing Verpackung Conditionnement
15	38,9	0854193700	PA 66 V-2	2000
		0855193790	PA 66 V-0	
	193700	Glow Wire 750° no flame	

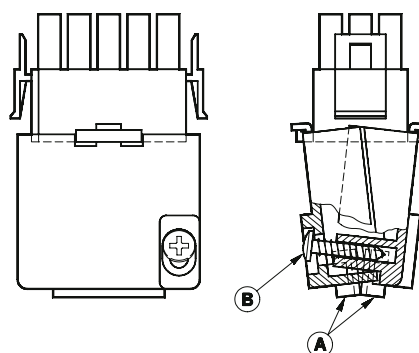

- Il codice riportato in tabella corrisponde a metà prodotto finito. Un serracavo completo è composto da due pezzi.
- Le viti **B** necessarie per l'assemblaggio 3,5 mm x 16 mm DIN 7981 non sono fornite da INARCA.
- L'inserto **A** attaccato alla scatola serracavo, può essere usato con cavi di diametro molto piccolo.

- Part number represent one half of a strain reiset. Two of a part number are required for one connector.
- The screw **B** 3,5 mm x 16 mm DIN 7981 needed for assembly are not supplied by INARCA.
- Insert **A** comes attached to strain relief. It can be used to provide additional adjustment for small wire bundles.

- Für eine Zugentlastung sind jeweils 2 Gehäusehälften erforderlich.
- Die für die Montage erforderlichen Schrauben **B** 3,5 mm x 16 mm DIN 7981 werden nicht von INARCA geliefert.
- Die Einlage **A** ist an der Zugentlastung angehängt. Sie wird benötigt, um eine zusätzliche Klemmwirkung bei dünnen Leitern zu erzielen.

- La pièce correspond à la moitié du produit fini; un serre-câble complet est composé de deux morceaux.
- Les vis **B** nécessaires pour l'assemblage 3,5 mm x 16 mm DIN 7981 ne sont pas fournies par INARCA.
- L'insert **A** fixé au boîtier serre-câble peut être utilisé avec des câbles d'un très petit diamètre.

Per gli Estrattori della Serie INAR-LOCK UNIVERSAL, fare riferimento alle "Attrezzature Manuali" della Sezione "M".

For the Extractors of INAR-LOCK UNIVERSAL Series, please referring to "Hand Tools" in Section "M"

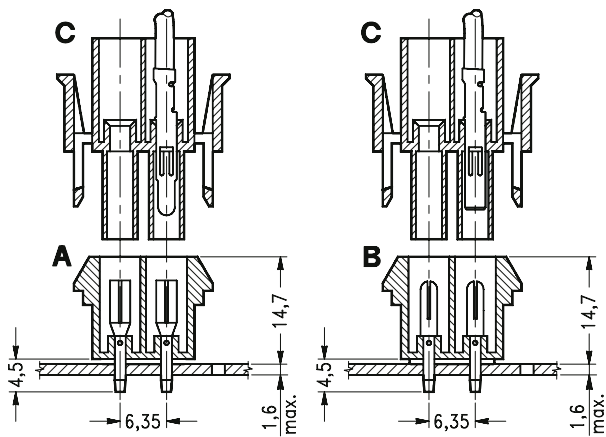

**INAR-LOCK SERIE C.S. - CONNETTORI PER SCHEDA
ESEMPIO D'APPLICAZIONE**

**INAR-LOCK C.S. SERIES - HOUSINGS FOR PRINTED CIRCUIT
EXAMPLE OF APPLIANCES**

**INAR-LOCK SERIE C.S. - GEHÄUSE FÜR GEDRUCKTE SCHALTUNG
VERWENDUNGBEISIEL**

**INAR-LOCK SERIE C.S. - CONNECTEURS POUR CIRCUIT IMPRIMÉ
EXEMPLE D'APPLICATION**

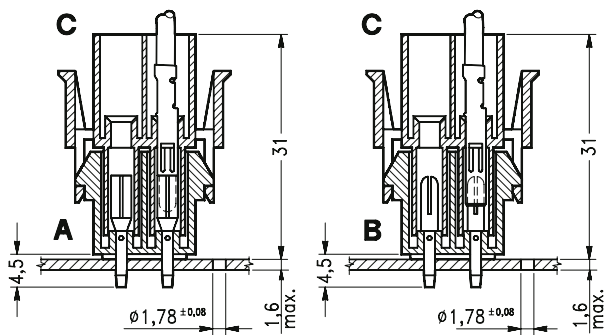

A- Connettori portamaschio con terminali femmina - Pin housings with socket terminals - Steckergehäuse mit rund steckhülsen - Connecteurs pour broche avec clips.

B- Connettori portamaschio con terminali maschio - Pin housings with pin terminals - Steckergehäuse mit runstecker - Connecteurs pour broche avec broche.

C- Connettori inseribili - Connectable housings - Einschaltbar gehäuse - Connecteurs inserable.

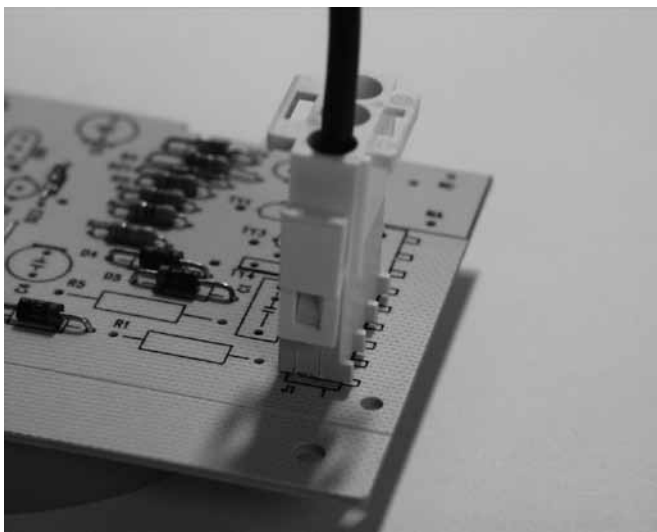

DIMA PER SCHEDA

PRINTED CIRCUIT LAYOUT

GEDRUCKTE LAYOUT

COTES DE PERCAGE DE CARTE

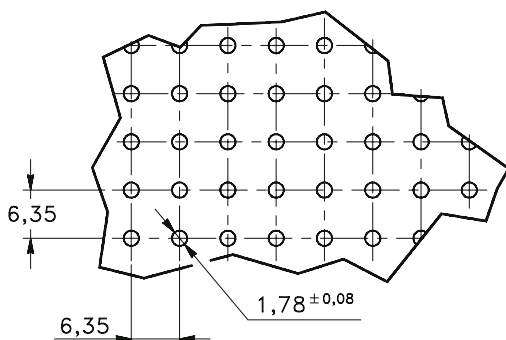

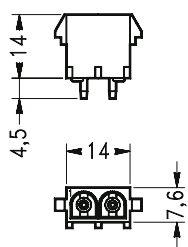

CONNETTORI PORTAMASCHIO C.S. 2 VIE
CON TERMINALI FEMMINA

TABS HOUSINGS C.S. 2 WAYS
WITH RECEPTACLES

STECKERGEHÄUSE C.S. 2-POLIG
MIT STECKHÜLSE

BOITIERS POUR BROCHES C.S. 2 VOIES
AVEC CLIPS

Tab. n°29

Nr. vie Ways No. Polzahl N. Voies	Codice Nr. P. N. Art. Nr. Code Nr.	Materiale Material Werkstoff Matiere	Materiale contatti Contact material Kontakt Material Matiere contacts	Confezione Packing Verpackung Conditionnement	Connessioni Connections Verbindungen Connexions
2	5490007700	PA 66 V-2	Cu Sn PRE-TIN	2000	0854052700
	5590007700	PA 66 V-0			
	..90007700	Glow Wire 750° no flame			

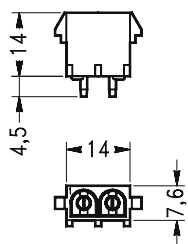

CONNETTORI PORTAMASCHIO C.S. 2 VIE
CON TERMINALI MASCHIO

TABS HOUSINGS C.S. 2 WAYS
WITH TABS

STECKERGEHÄUSE C.S. 2-POLIG
MIT STECKER

BOITIERS POUR BROCHES C.S. 2 VOIES
AVEC LANGUETTES

Tab. n° 30

Nr. vie Ways No. Polzahl N. Voies	Codice Nr. P. N. Art. Nr. Code Nr.	Materiale Material Werkstoff Matiere	Materiale contatti Contact material Kontakt Material Matiere contacts	Confezione Packing Verpackung Conditionnement	Connessioni Connections Verbindungen Connexions
2	5490001700	PA 66 V-2	Cu Sn PRE-TIN	2000	0854052700
	5590001700	PA 66 V-0			
	..90001700	Glow Wire 750° no flame			

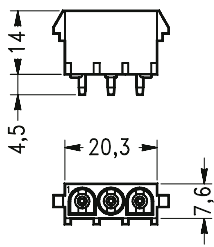

CONNETTORI PORTAMASCHIO C.S. 3 VIE
CON TERMINALI FEMMINA

TABS HOUSINGS C.S. 3 WAYS
WITH RECEPTACLES

STECKERGEHÄUSE C.S. 3-POLIG
MIT STECKHÜLSE

BOITIERS POUR BROCHES C.S. 3 VOIES
AVEC CLIPS

Tab. n° 31

Nr. vie Ways No. Polzahl N. Voies	Codice Nr. P. N. Art. Nr. Code Nr.	Materiale Material Werkstoff Matiere	Materiale contatti Contact material Kontakt Material Matiere contacts	Confezione Packing Verpackung Conditionnement	Connessioni Connections Verbindungen Connexions
3	5490008700	PA 66 V-2	Cu Sn PRE-TIN	2000	0854054700
	5590008700	PA 66 V-0			
	..90008700	Glow Wire 750° no flame			

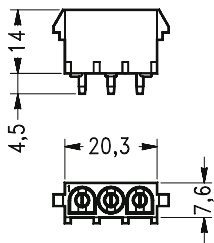

CONNETTORI PORTAMASCHIO C.S. CON 3 VIE
TERMINALI MASCHIO

TABS HOUSINGS C.S. 3 WAYS
WITH TABS

STECKERGEHÄUSE C.S. 3-POLIG
MIT STECKER

BOITIERS POUR BROCHES C.S. 3 VOIES
AVEC LANGUETTES

Tab. n° 32

Nr. vie Ways No. Polzahl N. Voies	Codice Nr. P. N. Art. Nr. Code Nr.	Materiale Material Werkstoff Matiere	Materiale contatti Contact material Kontakt Material Matiere contacts	Confezione Packing Verpackung Conditionnement	Connessioni Connections Verbindungen Connexions
3	5490002700	PA 66 V-2	Cu Sn PRE-TIN	2000	0854054700
	5590002700	PA 66 V-0			
	..90002700	Glow Wire 750° no flame			

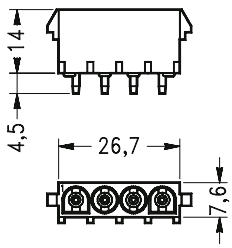

CONNETTORI PORTAMASCHIO C.S. 4 VIE
CON TERMINALI FEMMINA

TABS HOUSINGS C.S. 4 WAYS
WITH RECEPTACLES

STECKERGEHÄUSE C.S. 4-POLIG
MIT STECKHÜLSE

BOITIERS POUR BROCHES C.S. 4 VOIES
AVEC CLIPS

Tab. n° 33

Nr. vie Ways No. Polzahl N. Voies	Codice Nr. P. N. Art. Nr. Code Nr.	Materiale Material Werkstoff Matiere	Materiale contatti Contact material Kontakt Material Matiere contacts	Confezione Packing Verpackung Conditionnement	Connessioni Connections Verbindungen Connexions
4	5490009700	PA 66 V-2	Cu Sn PRE-TIN	2000	0854056700
	5590009700	PA 66 V-0			
	..90009700	Glow Wire 750° no flame			

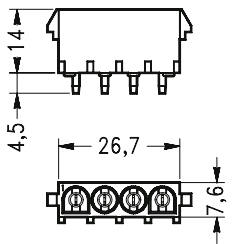

CONNETTORI PORTAMASCHIO C.S. 4 VIE
CON TERMINALI MASCHIO

TABS HOUSINGS C.S. 4 WAYS
WITH TABS

STECKERGEHÄUSE C.S. 3-POLIG
MIT STECKER

BOITIERS POUR BROCHES C.S. 4 VOIES
AVEC LANGUETTES

Tab. n° 34

Nr. vie Ways No. Polzahl N. Voies	Codice Nr. P. N. Art. Nr. Code Nr.	Materiale Material Werkstoff Matiere	Materiale contatti Contact material Kontakt Material Matiere contacts	Confezione Packing Verpackung Conditionnement	Connessioni Connections Verbindungen Connexions
4	5490003700	PA 66 V-2	Cu Sn PRE-TIN	2000	0854056700
	5590003700	PA 66 V-0			
	..90003700	Glow Wire 750° no flame			

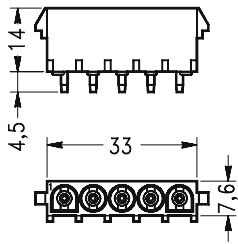

CONNETTORI PORTAMASCHIO C.S. 5 VIE
CON TERMINALI FEMMINA

TABS HOUSINGS C.S.5 WAYS
WITH RECEPTACLES

STECKERGEHÄUSE C.S. 5-POLIG
MIT STECKHÜLSE

BOITIERS POUR BROCHES C.S. 5 VOIES
AVEC CLIPS

Tab. n° 35

Nr. vie Ways No. Polzahl N. Voies	Codice Nr. P. N. Art. Nr. Code Nr.	Materiale Material Werkstoff Matiere	Materiale contatti Contact material Kontakt Material Matiere contacts	Confezione Packing Verpackung Conditionnement	Connessioni Connections Verbindungen Connexions
5	5490010700	PA 66 V-2	Cu Sn PRE-TIN	2000	0854058700
	5590010700	PA 66 V-0			
	..90010700	Glow Wire 750° no flame			

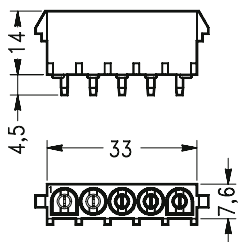

CONNETTORI PORTAMASCHIO C.S.5 VIE
CON TERMINALI MASCHIO

TABS HOUSINGS C.S. 5 WAYS
WITH TABS

STECKERGEHÄUSE C.S. 5-POLIG
MIT STECKER

BOITIERS POUR BROCHES C.S. 5 VOIES
AVEC LANGUETTES

Tab. n° 36

Nr. vie Ways No. Polzahl N. Voies	Codice Nr. P. N. Art. Nr. Code Nr.	Materiale Material Werkstoff Matiere	Materiale contatti Contact material Kontakt Material Matiere contacts	Confezione Packing Verpackung Conditionnement	Connessioni Connections Verbindungen Connexions
5	5490004700	PA 66 V-2	Cu Sn PRE-TIN	2000	0854058700
	5590004700	PA 66 V-0			
	..90004700	Glow Wire 750° no flame			

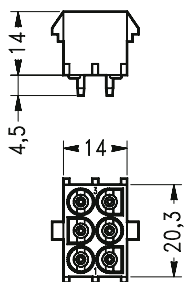

CONNETTORI PORTAMASCHIO C.S. 6 VIE
CON TERMINALI FEMMINA

TABS HOUSINGS C.S. 6 WAYS
WITH RECEPTACLES

STECKERGEHÄUSE C.S. 6-POLIG
MIT STECKHÜLSE

BOITIERS POUR BROCHES C.S. 6 VOIES
AVEC CLIPS

Tab. n° 37

Nr. vie Ways No. Polzahl N. Voies	Codice Nr. P. N. Art. Nr. Code Nr.	Materiale Material Werkstoff Matiere	Materiale contatti Contact material Kontakt Material Matiere contacts	Confezione Packing Verpackung Conditionnement	Connessioni Connections Verbindungen Connexions
6	5490012700	PA 66 V-2	Cu Sn PRE-TIN	2000	0854060700
	5590012700	PA 66 V-0			
	..90012700	Glow Wire 750° no flame			

10

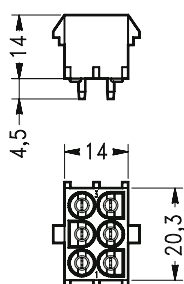

CONNETTORI PORTAMASCHIO C.S. CON 6 VIE
TERMINALI MASCHIO

TABS HOUSINGS C.S. 6 WAYS
WITH TABS

STECKERGEHÄUSE C.S. 6-POLIG
MIT STECKER

BOITIERS POUR BROCHES C.S. 6 VOIES
AVEC LANGUETTES

Tab. n° 38

Nr. vie Ways No. Polzahl N. Voies	Codice Nr. P. N. Art. Nr. Code Nr.	Materiale Material Werkstoff Matiere	Materiale contatti Contact material Kontakt Material Matiere contacts	Confezione Packing Verpackung Conditionnement	Connessioni Connections Verbindungen Connexions
6	5490006700	PA 66 V-2	Cu Sn PRE-TIN	2000	0854060700
	5590006700	PA 66 V-0			
	..90006700	Glow Wire 750° no flame			

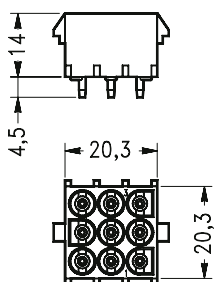

CONNETTORI PORTAMASCHIO C.S. 9 VIE
CON TERMINALI FEMMINA

TABS HOUSINGS C.S. 9 WAYS
WITH RECEPTACLES

STECKERGEHÄUSE C.S. 9-POLIG
MIT STECKHÜLSE

BOITIERS POUR BROCHES C.S. 9 VOIES
AVEC CLIPS

Tab. n° 39

Nr. vie Ways No. Polzahl N. Voies	Codice Nr. P. N. Art. Nr. Code Nr.	Materiale Material Werkstoff Matiere	Materiale contatti Contact material Kontakt Material Matiere contacts	Confezione Packing Verpackung Conditionnement	Connessioni Connections Verbindungen Connexions
9	5490016700	PA 66 V-2	Cu Sn PRE-TIN	2000	0854062700
	5590016700	PA 66 V-0			
	..90016700	Glow Wire 750° no flame			

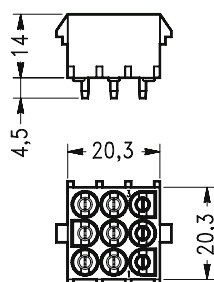

CONNETTORI PORTAMASCHIO C.S. 9 VIE
CON TERMINALI MASCHIO

TABS HOUSINGS C.S. 9 WAYS
WITH TABS

STECKERGEHÄUSE C.S. 9-POLIG
MIT STECKER

BOITIERS POUR BROCHES C.S. 9 VOIES
AVEC LANGUETTES

Tab. n° 40

Nr. vie Ways No. Polzahl N. Voies	Codice Nr. P. N. Art. Nr. Code Nr.	Materiale Material Werkstoff Matiere	Materiale contatti Contact material Kontakt Material Matiere contacts	Confezione Packing Verpackung Conditionnement	Connessioni Connections Verbindungen Connexions
9	5490013700	PA 66 V-2	Cu Sn PRE-TIN	2000	0854062700
	5590013700	PA 66 V-0			
	..90013700	Glow Wire 750° no flame			

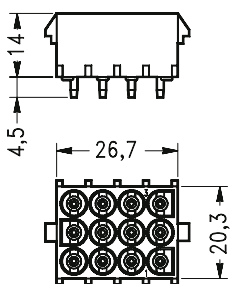

CONNETTORI PORTAMASCHIO C.S. 12 VIE
CON TERMINALI FEMMINA

TABS HOUSINGS C.S. 12 WAYS
WITH RECEPTACLES

STECKERGEHÄUSE C.S. 12-POLIG
MIT STECKHÜLSE

BOITIERS POUR BROCHES C.S. 12 VOIES
AVEC CLIPS

Tab. n° 41

Nr. vie Ways No. Polzahl N. Voies	Codice Nr. P. N. Art. Nr. Code Nr.	Materiale Material Werkstoff Matiere	Materiale contatti Contact material Kontakt Material Matiere contacts	Confezione Packing Verpackung Conditionnement	Connessioni Connections Verbindungen Connexions
12	5490017700	PA 66 V-2	Cu Sn PRE-TIN	1000	0854064700
	5590017700	PA 66 V-0			
	..90017700	Glow Wire 750° no flame			

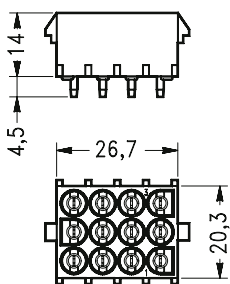

CONNETTORI PORTAMASCHIO C.S. 12 VIE
CON TERMINALI MASCHIO

TABS HOUSINGS C.S. 12 WAYS
WITH TABS

STECKERGEHÄUSE C.S. 12-POLIG
MIT STECKER

BOITIERS POUR BROCHES C.S. 12 VOIES
AVEC LANGUETTES

Tab. n° 42

Nr. vie Ways No. Polzahl N. Voies	Codice Nr. P. N. Art. Nr. Code Nr.	Materiale Material Werkstoff Matiere	Materiale contatti Contact material Kontakt Material Matiere contacts	Confezione Packing Verpackung Conditionnement	Connessioni Connections Verbindungen Connexions
12	5490014700	PA 66 V-2	Cu Sn PRE-TIN	1000	0854064700
	5590014700	PA 66 V-0			
	..90014700	Glow Wire 750° no flame			

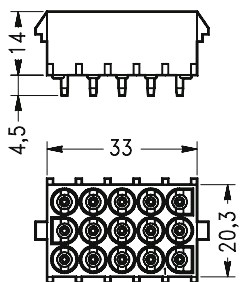

CONNETTORI PORTAMASCHIO C.S. 15 VIE
CON TERMINALI FEMMINA

TABS HOUSINGS C.S.15 WAYS
WITH RECEPTACLES

STECKERGEHÄUSE C.S. 15-POLIG
MIT STECKHÜLSE

BOITIERS POUR BROCHES C.S. 15 VOIES
AVEC CLIPS

Tab. n° 43

Nr. vie Ways No. Polzahl N. Voies	Codice Nr. P. N. Art. Nr. Code Nr.	Materiale Material Werkstoff Matiere	Materiale contatti Contact material Kontakt Material Matiere contacts	Confezione Packing Verpackung Conditionnement	Connessioni Connections Verbindungen Connexions
15	5490018700	PA 66 V-2	Cu Sn PRE-TIN	1000	0854066700
	5590018700	PA 66 V-0			
	..90018700	Glow Wire 750° no flame			

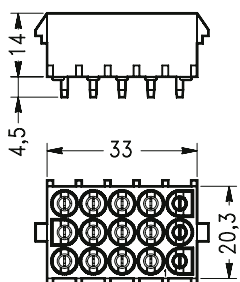

CONNETTORI PORTAMASCHIO C.S. 15 VIE
CON TERMINALI MASCHIO

TABS HOUSINGS C.S. 15 WAYS
WITH TABS

STECKERGEHÄUSE C.S. 15-POLIG
MIT STECKER

BOITIERS POUR BROCHES C.S. 15 VOIES
AVEC LANGUETTES

Tab. n° 44

Nr. vie Ways No. Polzahl N. Voies	Codice Nr. P. N. Art. Nr. Code Nr.	Materiale Material Werkstoff Matiere	Materiale contatti Contact material Kontakt Material Matiere contacts	Confezione Packing Verpackung Conditionnement	Connessioni Connections Verbindungen Connexions
15	5490015700	PA 66 V-2	Cu Sn PRE-TIN	1000	0854066700
	5590015700	PA 66 V-0			
	..90015700	Glow Wire 750° no flame			

**INAR-LOCK SERIE C.S. / 90° - CONNETTORI PER SCHEDA
ESEMPIO D'APPLICAZIONE**

**INAR-LOCK C.S. / 90° SERIES - HOUSINGS FOR PRINTED CIRCUIT
EXAMPLE OF APPLIANCES**

**INAR-LOCK SERIE C.S. / 90° - GEHÄUSE FÜR GEDRUCKTE SCHALTUNG
VERWENDUNGBEISIEL**

**INAR-LOCK SERIE C.S. / 90° - CONNECTEURS POUR CIRCUIT IMPRIMÉ
EXAMPLE D'APPLICATION**

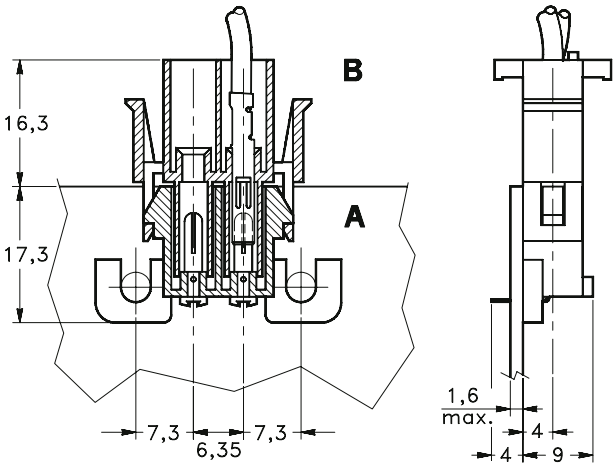
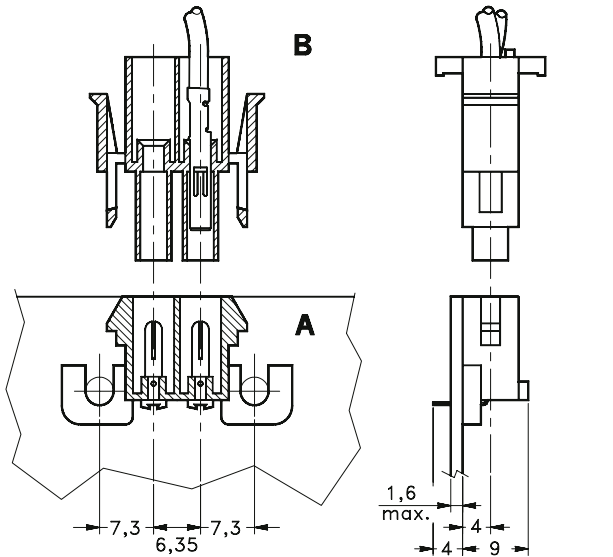

A- Connettori portamaschio con terminali femmina - Pin housings with socket terminals - Steckergehäuse mit rund steckhülsen - Connecteurs pour broche avec clips.

B- Connettori inseribili - Connectable housings - Einschaltbar gehäuse - Connecteurs inserable.

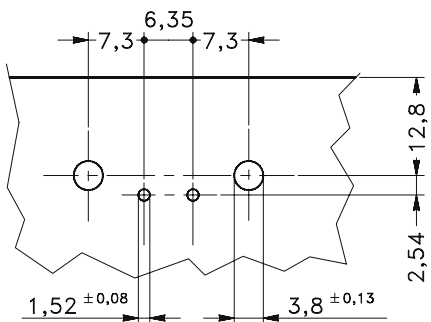
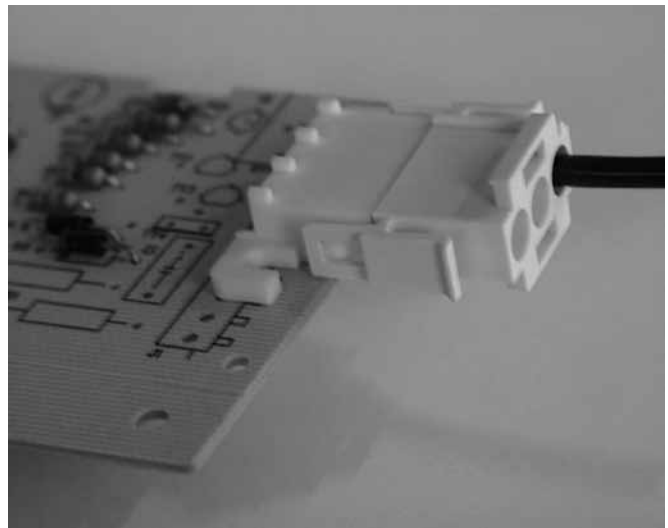

DIMA PER SCHEDA

PRINTED CIRCUIT LAYOUT

GEDRUCKTE LAYOUT

COTES DE PERCAGE DE CARTE

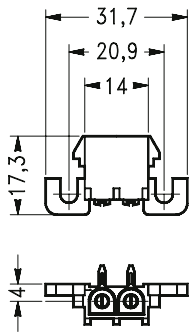

CONNETTORI PORTAMASCHIO C.S. 2 VIE
90°

TABS HOUSINGS C.S. 2 WAYS
90°

STECKERGEHÄUSE C.S. 2-POLIG
90°

BOITIERS POUR BROCHES C.S. 2 VOIES
90°

Tab. n° 45

Nr. vie Ways No. Polzahl N. Voies	Codice Nr. P. N. Art. Nr. Code Nr.	Materiale Material Werkstoff Matiere	Materiale contatti Contact material Kontakt Material Matiere contacts	Confezione Packing Verpackung Conditionnement	Connessioni Connections Verbindungen Connexions
2	5490019700	PA 66 V-2	Cu Sn PRE-TIN	2000	0854052700
	5590019700	PA 66 V-0			
	..90019700	Glow Wire 750° no flame			

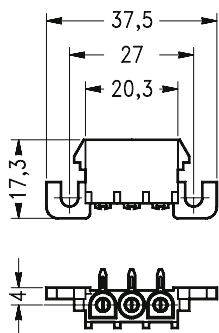

CONNETTORI PORTAMASCHIO C.S. 3 VIE
90°

TABS HOUSINGS C.S. 3 WAYS
90°

STECKERGEHÄUSE C.S. 3-POLIG
90°

CBOITIERS POUR BROCHES C.S. 3 VOIES
90°

Tab. n° 46

Nr. vie Ways No. Polzahl N. Voies	Codice Nr. P. N. Art. Nr. Code Nr.	Materiale Material Werkstoff Matiere	Materiale contatti Contact material Kontakt Material Matiere contacts	Confezione Packing Verpackung Conditionnement	Connessioni Connections Verbindungen Connexions
3	5490020700	PA 66 V-2	Cu Sn PRE-TIN	2000	0854054700
	5590020700	PA 66 V-0			
	..90020700	Glow Wire 750° no flame			

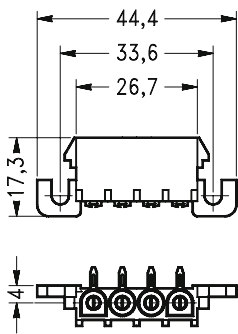

CONNETTORI PORTAMASCHIO C.S. 4 VIE
90°

TABS HOUSINGS C.S. 4 WAYS
90°

STECKERGEHÄUSE C.S. 4-POLIG
90°

BOITIERS POUR BROCHES C.S. 4 VOIES
90°

Tab. n° 47

Nr. vie Ways No. Polzahl N. Voies	Codice Nr. P. N. Art. Nr. Code Nr.	Materiale Material Werkstoff Matiere	Materiale contatti Contact material Kontakt Material Matiere contacts	Confezione Packing Verpackung Conditionnement	Connessioni Connections Verbindungen Connexions
4	5490021700	PA 66 V-2	Cu Sn PRE-TIN	2000	0854056700
	5590021700	PA 66 V-0			
	..90021700	Glow Wire 750° no flame			

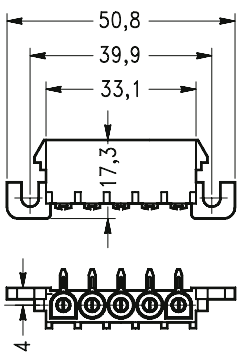

CONNETTORI PORTAMASCHIO C.S. 5 VIE
90°

TABS HOUSINGS C.S. 5 WAYS
90°

STECKERGEHÄUSE C.S. 5-POLIG
90°

BOITIERS POUR BROCHES C.S. 5 VOIES
90°

Tab. n° 48

Nr. vie Ways No. Polzahl N. Voies	Codice Nr. P. N. Art. Nr. Code Nr.	Materiale Material Werkstoff Matiere	Materiale contatti Contact material Kontakt Material Matiere contacts	Confezione Packing Verpackung Conditionnement	Connessioni Connections Verbindungen Connexions
5	5490022700	PA 66 V-2	Cu Sn PRE-TIN	2000	0854058700
	5590022700	PA 66 V-0			
	..90022700	Glow Wire 750° no flame			

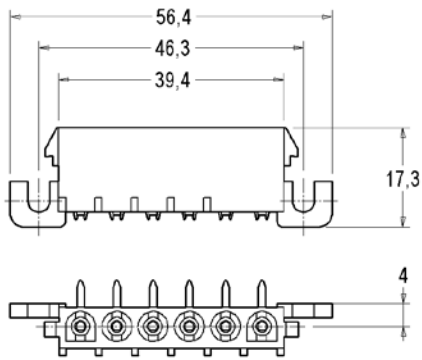

CONNETTORI PORTAMASCHIO C.S. 6 VIE
90°

TABS HOUSINGS C.S. 6 WAYS
90°

STECKERGEHÄUSE C.S. 6-POLIG
90°

BOITIERS POUR BROCHES C.S. 6 VOIES
90°

Tab. n° 49

Nr. vie Ways No. Polzahl N. Voies	Codice Nr. P. N. Art. Nr. Code Nr.	Materiale Material Werkstoff Matiere	Materiale contatti Contact material Kontakt Material Matiere contacts	Confezione Packing Verpackung Conditionnement	Connessioni Connections Verbindungen Connexions
6	5490031700	PA 66 V-2	Cu Sn PRE-TIN	2000	0854069700
	5590031700	PA 66 V-0			5450398700
	..90031700	Glow Wire 750° no flame			

TIPO
TYPE
TYP
TYPE
B

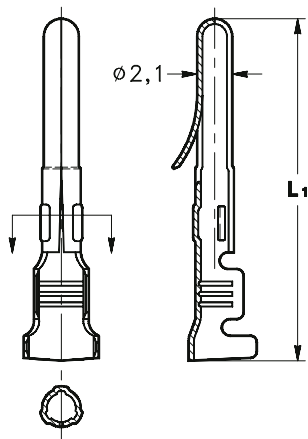

TERMINALI MASCHIO STANDARD

STANDARD PIN CONTACTS

STANDARD STIFT KONTAKTE

CONTACTS BROCHE STANDARD

Tab. n° 50

Tipo Type Typ Type	Sezione cavo Wire range Nennquerschnitt Section cable	Ø Isolante Ø Insulation Ø Gaine	L1	Codice Nr. P. N. Art. Nr. Code Nr.	Materiale Material Werkstoff Matiere	Confezione Packing Verpackung Conditionnement
B	0,3 ÷ 1	1,4 ÷ 2,5	20,5	0011017101	Cu Zn PRE-TIN	5000x5
				0011017501	Cu Zn gal Au	
				0111017101	Cu Sn PRE-TIN	
				0111017501	Cu Sn gal Au	
B	0,5 ÷ 2	1,9 ÷ 3,7	20,5	0011036101	Cu Zn PRE-TIN	4800x5
				0011036501	Cu Zn gal Au	
				0111036101	Cu Sn PRE-TIN	
				0111036501	Cu Sn gal Au	

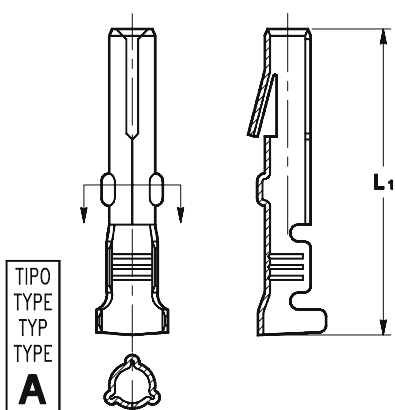

TERMINALI FEMMINA STANDARD

STANDARD SOCKET CONTACTS

STANDARD BUCHSE KONTAKTE

CONTACTS DOUILLE STANDARD

Tab. n° 51

TIPO Type Typ Type A	Sezione cavo Wire range Nennquerschnitt Section cable	Ø Isolante Ø Insulation Ø Isolation Ø Gaine	L1	Codice Nr. P. N. Art. Nr. Code Nr.	Materiale Material Werkstoff Matiere	Confezione Packing Verpackung Conditionnement
A	0,3 ÷ 1	1,4 ÷ 2,5	18	0011016101	Cu Zn PRE-TIN	5000x5
				0011016501	Cu Zn gal Au	
				0111016101	Cu Sn PRE-TIN	
				0111016501	Cu Sn gal Au	
A	0,5 ÷ 2	1,9 ÷ 3,7	18	0011035101	Cu Zn PRE-TIN	4800x5
				0011035501	Cu Zn gal Au	
				0111035101	Cu Sn PRE-TIN	
				0111035501	Cu Sn gal Au	

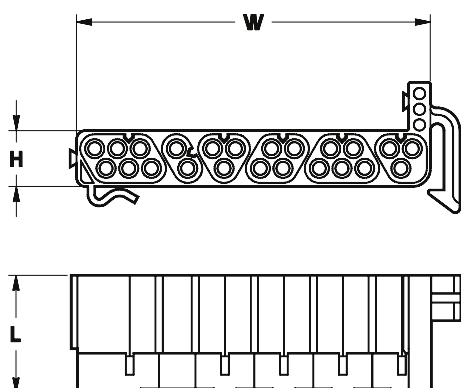

CONNETTORI FEMMINA STANDARD 23 VIE

CAP HOUSINGS STANDARD 23 WAYS

AUFNAHMEGEHÄUSE STANDARD 23-POLIG

BOITIERS FEMELLE STANDARD 23 VOIES

Tab. n° 52

Nr. vie Ways No. Polzahl N. Voies	H	L	W	Codice Nr. P. N. Art. Nr. Code Nr.	Materiale Material Werkstoff Matiere	Confezione Packing Verpackung Conditionnement
23	12,3	25,9	78	0854223760	PA 66 V-2	1000
				0855223700	PA 66 V-0	
			223700	Glow Wire 750° no flame	

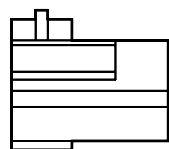
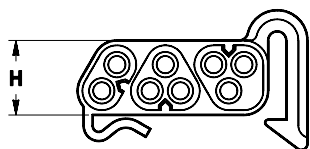

CONNETTORI FEMMINA STANDARD 8 VIE

CAP HOUSINGS STANDARD 8 WAYS

AUFNAHMEGEHÄUSE STANDARD 8-POLIG

BOITIERS FEMELLE STANDARD 8 VOIES

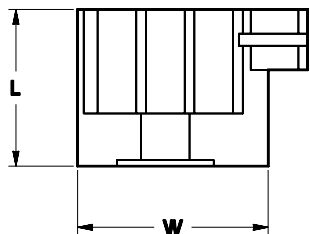

Tab. n° 53

Nr. vie Ways No. Polzahl N. Voies	H	L	W	Codice Nr. P. N. Art. Nr. Code Nr.	Materiale Material Werkstoff Matiere	Confezione Packing Verpackung Conditionnement
8	12,3	25,9	31,5	0854068760	PA 66 V-2	3500
				0855068700	PA 66 V-0	
			068700	Glow Wire 750° no flame	

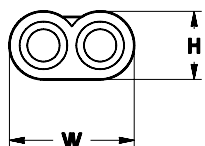
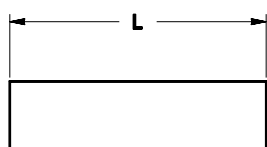

CONNETTORI MASCHIO STANDARD 2 VIE

PLUG HOUSINGS STANDARD 2 WAYS

STECKERGEHÄUSE STANDARD 2-POLIG

BOITIERS MALE STANDARD 2 VOIES

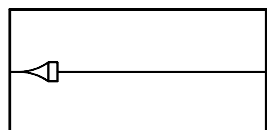

Tab. n° 54

Nr. vie Ways No. Polzahl N. Voies	H	L	W	Codice Nr. P. N. Art. Nr. Code Nr.	Materiale Material Werkstoff Matiere	Confezione Packing Verpackung Conditionnement
2	6	22,6	11	0854075760	PA 66 V-2	20000
				0855075700	PA 66 V-0	
			075700	Glow Wire 750° no flame	

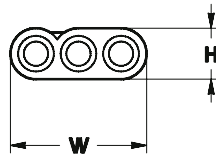
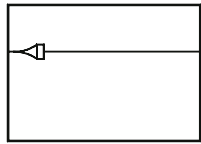
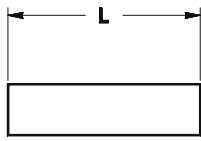

CONNETTORI MASCHIO STANDARD 3 VIE

PLUG HOUSINGS STANDARD 3 WAYS

STECKERGEHÄUSE STANDARD 3-POLIG

BOITIERS MALE STANDARD 3 VOIES

Tab. n° 545

Nr. vie Ways No. Polzahl N. Voies	H	L	W	Codice Nr. P. N. Art. Nr. Code Nr.	Materiale Material Werkstoff Matiere	Confezione Packing Verpackung Conditionnement
3	6	22,6	16	0854209700	PA 66 V-2	10000
				0855209700	PA 66 V-0	
			209700	Glow Wire 750° no flame	

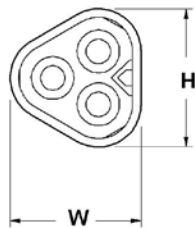
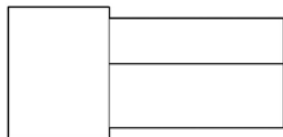
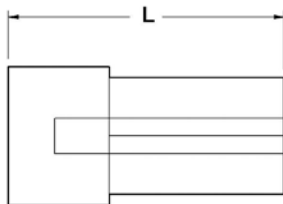

CONNETTORI FEMMINA STANDARD 3 VIE

CAP HOUSINGS STANDARD 3 WAYS

AUFNAHMEGEHÄUSE STANDARD 3-POLIG

BOITIERS FEMELLE STANDARD 3 VOIES

Tab. n° 56

Nr. vie Ways No. Polzahl N. Voies	H	L	W	Codice Nr. P. N. Art. Nr. Code Nr.	Materiale Material Werkstoff Matiere	Confezione Packing Verpackung Conditionnement
3	13	25,9	12,3	0854078760	PA 66 V-2	15000
				0855078700	PA 66 V-0	
			078700	Glow Wire 750° no flame	

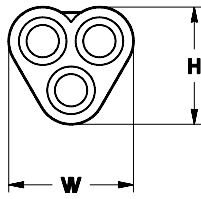
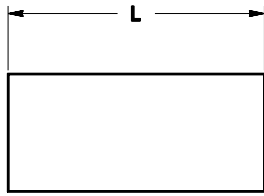

CONNETTORI MASCHIO STANDARD 3 VIE

PLUG HOUSINGS STANDARD 3 WAYS

STECKERGEHÄUSE STANDARD 3-POLIG



BOITIERS MALE STANDARD 3 VOIES

Tab. n° 57

Nr. vie Ways No. Polzahl N. Voies	H	L	W	Codice Nr. P. N. Art. Nr. Code Nr.	Materiale Material Werkstoff Matiere	Confezione Packing Verpackung Conditionnement
3	10,3	22,6	11	0854070760	PA 66 V-2	15000
				0855070700	PA 66 V-0	
			070700	Glow Wire 750° no flame	

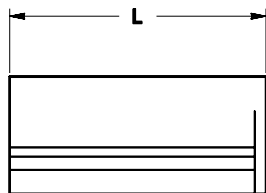
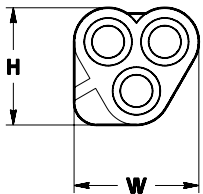

CONNETTORI MASCHIO STANDARD 3 VIE

PLUG HOUSINGS FOR SOCKETS STANDARD 3 WAYS

STECKERGEHÄUSE STANDARD 3-POLIG



BOITIERS MALE STANDARD 3 VOIES

Tab. n° 58

Nr. vie Ways No. Polzahl N. Voies	H	L	W	Codice Nr. P. N. Art. Nr. Code Nr.	Materiale Material Werkstoff Matiere	Confezione Packing Verpackung Conditionnement
3	10,3	22,6	11	0854071760	PA 66 V-2	15000
				0855071700	PA 66 V-0	
			071700	Glow Wire 750° no flame	

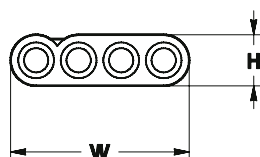
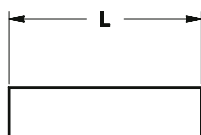

CONNETTORI MASCHIO STANDARD 4 VIE

PLUG HOUSINGS STANDARD 4 WAYS

STECKERGEHÄUSE STANDARD 4-POLIG

BOITIERS MALE STANDARD 4 VOIES

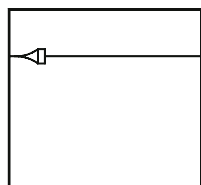

Tab. n°59

Nr. vie Ways No. Polzahl N. Voies	H	L	W	Codice Nr. P. N. Art. Nr. Code Nr.	Materiale Material Werkstoff Matiere	Confezione Packing Verpackung Conditionnement
4	6	22,6	21	0855208700	PA 66 V-0	10000
				0854208700	PA 66 V-2	
			208700	Glow Wire 750° no flame	

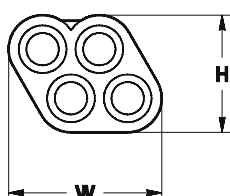
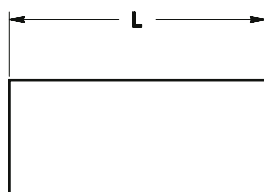

CONNETTORI MASCHIO STANDARD 4 VIE

PLUG HOUSINGS STANDARD 4 WAYS

STECKERGEHÄUSE STANDARD 4-POLIG

BOITIERS MALE STANDARD 4 VOIES

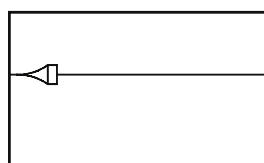

Tab. n°60

Nr. vie Ways No. Polzahl N. Voies	H	L	W	Codice Nr. P. N. Art. Nr. Code Nr.	Materiale Material Werkstoff Matiere	Confezione Packing Verpackung Conditionnement
4	10,3	22,6	13,5	0854072760	PA 66 V-2	10000
				0855072700	PA 66 V-0	
			072700	Glow Wire 750° no flame	

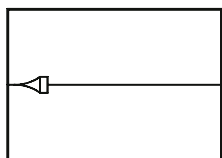
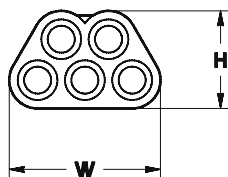
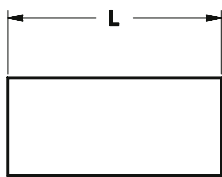

CONNETTORI MASCHIO STANDARD 5 VIE

PLUG HOUSINGS STANDARD 5 WAYS

STECKERGEHÄUSE STANDARD 5-POLIG

BOITIERS MALE STANDARD 5 VOIES

Tab. n° 61

Nr. vie Ways No. Polzahl N. Voies	H	L	W	Codice Nr. P. N. Art. Nr. Code Nr.	Materiale Material Werkstoff Matiere	Confezione Packing Verpackung Conditionnement
5	10,3	22,6	16	0854077760	PA 66 V-2	10000
				0855077700	PA 66 V-0	
			077700	Glow Wire 750° no flame	

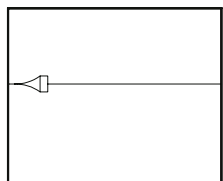
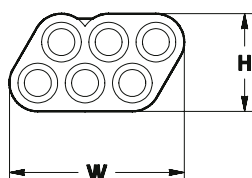
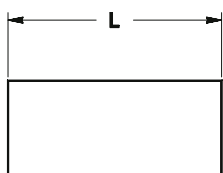

CONNETTORI MASCHIO STANDARD 6 VIE

PLUG HOUSINGS STANDARD 6 WAYS

STECKERGEHÄUSE STANDARD 6-POLIG

BOITIERS MALE STANDARD 6 VOIES

Tab. n° 62

Nr. vie Ways No. Polzahl N. Voies	H	L	W	Codice Nr. P. N. Art. Nr. Code Nr.	Materiale Material Werkstoff Matiere	Confezione Packing Verpackung Conditionnement
6	10,3	22,6	18,5	0854073760	PA 66 V-2	8000
				0855073700	PA 66 V-0	
			073700	Glow Wire 750° no flame	

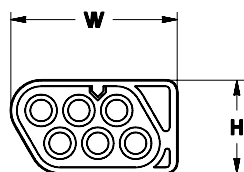
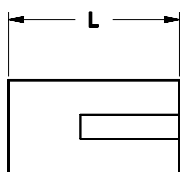

CONNETTORI FEMMINA STANDARD 6 VIE

CAP HOUSINGS STANDARD 6 WAYS

AUFNAHMEGEHÄUSE STANDARD 6-POLIG

BOITIERS FEMELLE STANDARD 6 VOIES

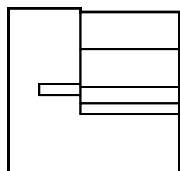

Tab. n° 63

Nr. vie Ways No. Polzahl N. Voies	H	L	W	Codice Nr. P. N. Art. Nr. Code Nr.	Materiale Material Werkstoff Matiere	Confezione Packing Verpackung Conditionnement
6	12,3	25,9	22	0854082760	PA 66 V-2	5000
				0855082700	PA 66 V-0	
				...082700	Glow Wire 750° no flame	

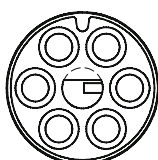
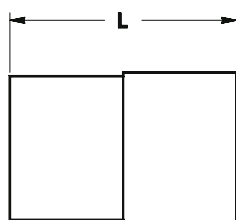

CONNETTORI MASCHIO STANDARD 6 VIE
CIRCOLARE

PLUG HOUSINGS STANDARD 6 WAYS
ROUND

STECKERGEHÄUSE STANDARD 6-POLIG
RUND

BOITIERS MALE STANDARD 6 VOIES
CIRCULAIRE

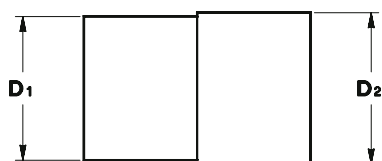

Tab. n° 64

Nr. vie Ways No. Polzahl N. Voies	D 1	D 2	L	Codice Nr. P. N. Art. Nr. Code Nr.	Materiale Material Werkstoff Matiere	Confezione Packing Verpackung Conditionnement
6	15,2	16	24	0854074750	PA 66 V-2	5000
				0855074700	PA 66 V-0	
			074700	Glow Wire 750° no flame	

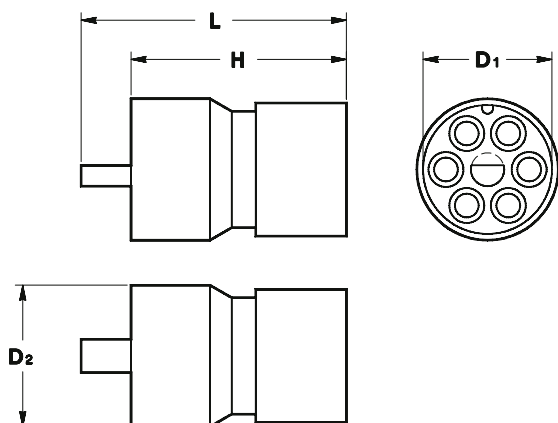

CONNETTORI FEMMINA STANDARD 6 VIE
CIRCOLARE

CAP HOUSINGS STANDARD 6 WAYS
ROUND

AUFNAHMEGEHÄUSE STANDARD 6-POLIG
RUND

BOITIERS FEMELLE STANDARD 6 VOIES
CIRCULAIRE

Tab. n° 65

Nr. vie Ways No. Polzahl N. Voies	D 1	D 2	H	L	Codice Nr. P. N. Art. Nr. Code Nr.	Materiale Material Werkstoff Matiere	Confezione Packing Verpackung Conditionnement
6	16	17	26	32,2	0854076750	PA 66 V-2	5000
					0855076700	PA 66 V-0	
				076700	Glow Wire 750° no flame	

INAR-LOCK SERIE STANDARD

MONTAGGIO ARTICOLI CODICE Nr. 0854082700 E 0854223700

P.N. 0854082700 AND 0854223700 ARTICLES ASSEMBLY

MONTAGE VON ARTIKELN BEST. Nr. 0854082700 UND 0854223700

MOUNTAGE DES ARTICLES CODE Nr. 0854082700 ET 0854223700

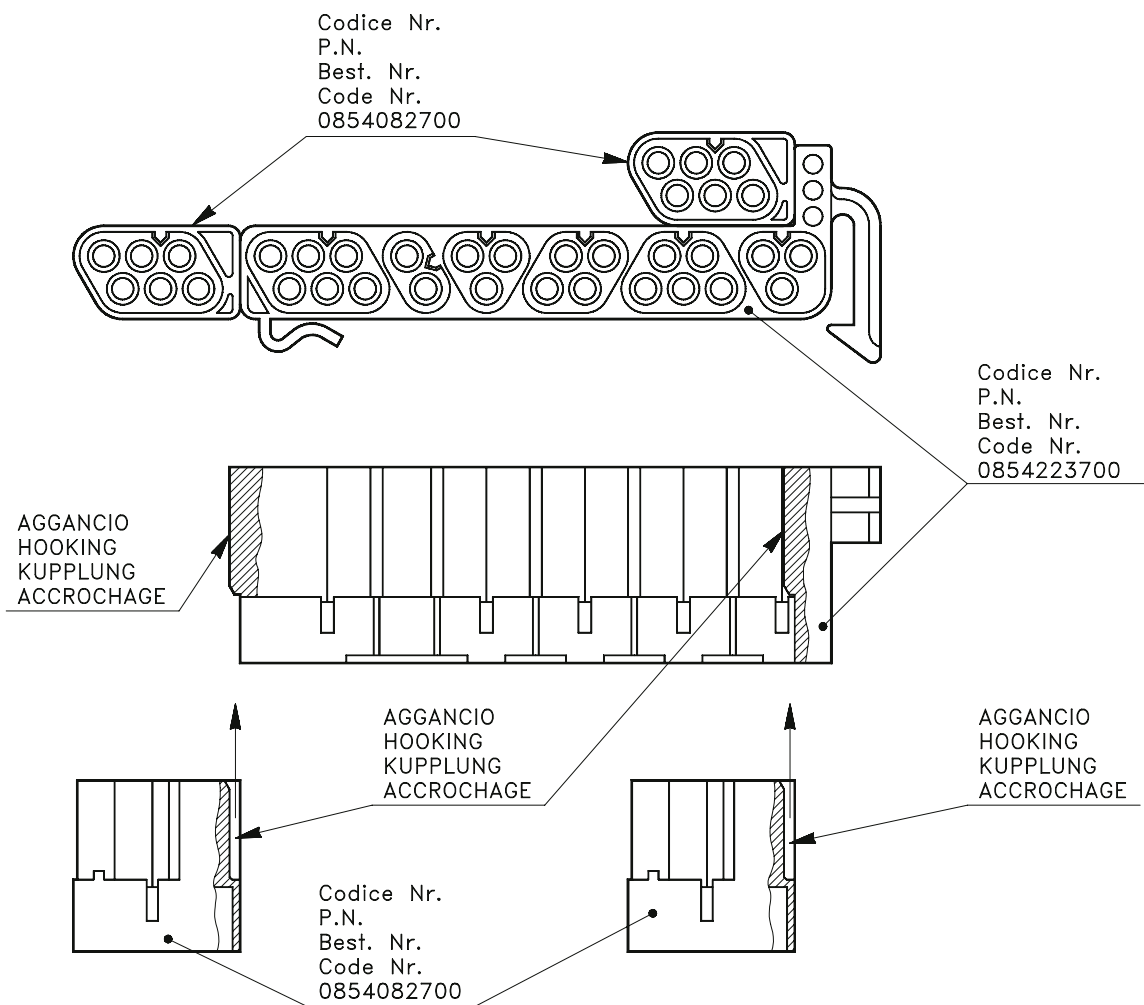

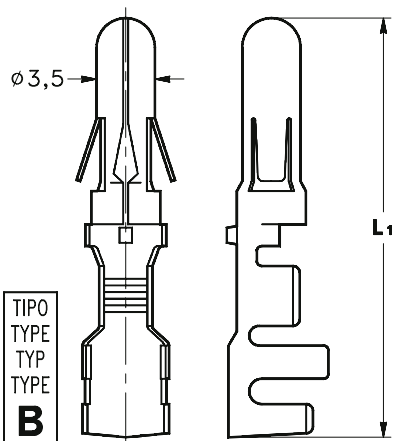

TERMINALI MASCHIO GIANT

GIANT PIN CONTACTS

GIANT STIFT KONTAKTE

CONTACTS BROCHE GIANT

Tab. n° 66

Tipo Type Typ Type	Sezione cavo Wire range Nennquerschnitt Section câble	Ø Isolante Ø Insulation Ø Isolation Ø Gaine	L1	Codice Nr. P. N. Art. Nr. Code Nr.	Materiale Material Werkstoff Matiere	Confezione Packing Verpackung Conditionnement
B	0,5 ÷ 1,5	1,9 ÷ 3,3	25,2	0011222101	Cu Zn PRE-TIN	2500x4
				0011222501	Cu Zn gal Au	
				0111222101	Cu Sn PRE-TIN	
				0111222501	Cu Sn gal Au	
B	2,5 ÷ 4	4 ÷ 4,5	25,2	0011230101	Cu Zn PRE-TIN	2500x4
				0011230501	Cu Zn gal Au	
				0111230101	Cu Sn PRE-TIN	
				0111230501	Cu Sn gal Au	

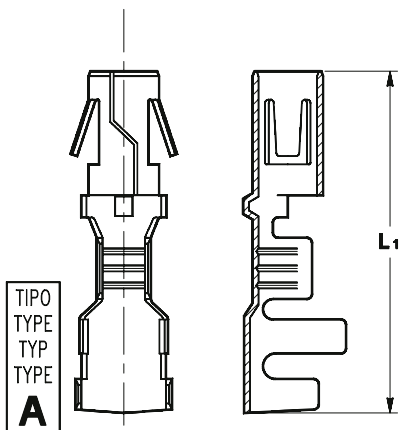

TERMINALI FEMMINA GIANT

GIANT SOCKET CONTACTS

GIANT BUCHSE KONTAKTE

CONTACTS DOUILLE GIANT

Tab. n° 67

Tipo Type Typ Type	Sezione cavo Wire range Nennquerschnitt Section cable	Ø Isolante Ø Insulation Ø Isolation Ø Gaine	L1	Codice Nr. P. N. Art. Nr. Code Nr.	Materiale Material Werkstoff Matiere	Confezione Packing Verpackung Conditionnement
A	0,5 ÷ 1,5	1,9 ÷ 3,3	20,1	0011223101	Cu Zn PRE-TIN	2500x5
				0011223501	Cu Zn gal Au	
				0111223101	Cu Sn PRE-TIN	
				0111223501	Cu Sn gal Au	
A	2,5 ÷ 4	4 ÷ 4,5	20,1	0011231101	Cu Zn PRE-TIN	2500x5
				0011231501	Cu Zn gal Au	
				0111231101	Cu Sn PRE-TIN	
				0111231501	Cu Sn gal Au	