

PRODOTTI INAR-MINILOCK PER CONNESSIONI MULTIPLE
INAR-MINILOCK PRODUCTS FOR MULTI-WAY CONNECTIONS
INAR-MINILOCK PRODUKTE FÜR VIELFACHANSCHLÜSSE
PRODUITS INAR-MINILOCK POUR CONNEXIONS MULTIPLES

TERMINALI INAR-MINILOCK UNIVERSAL	CONTACTS INAR-MINILOCK UNIVERSAL	KONTAKTE INAR-MINILOCK UNIVERSAL	CONTACTS INAR-MINILOCK UNIVERSAL	9.6
CONNETTORI INAR-MINILOCK UNIVERSAL	HOUSINGS INAR-MINILOCK UNIVERSAL	GEHÄUSE INAR-MINILOCK UNIVERSAL	BOITIERS INAR-MINILOCK UNIVERSAL	9.7
ESTRATTORI PER INAR-MINILOCK UNIVERSAL	EXTRACTORS FOR INAR-MINILOCK UNIVERSAL	AUSWERFER FÜR INAR-MINILOCK UNIVERSAL	EXTRACTEURS POUR INAR-MINILOCK UNIVERSAL	9.19

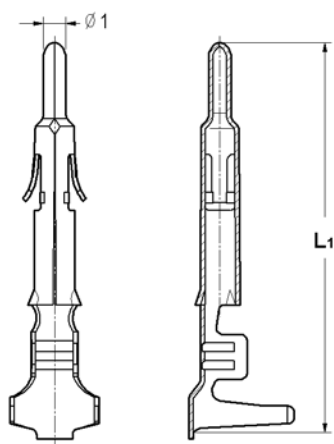

TERMINALI MASCHIO UNIVERSAL

UNIVERSAL PIN CONTACTS

UNIVERSAL STIFT KONTAKTE

CONTACTS BROCHE UNIVERSAL

Tab. n° 1

Sezione cavo Wire range Nennquerschnitt Section câble	\varnothing Isolante \varnothing Insulation \varnothing Isolation \varnothing Gaine	L1	Codice Nr. P. N. Art. Nr. Code Nr.	Materiale Material Werkstoff Matiere	Confezione Packing Verpackung Conditionnement	Nota Note Anmerk. Note
0,12 ÷ 0,35	1,2 ÷ 1,8	17,2	0011585101	Cu Zn PRE-TIN	5000x5	
0,35 ÷ 0,9	1,5 ÷ 2,4	17,2	0011586101	Cu Zn PRE-TIN	5000x5	[w]
0,5 ÷ 1,3	1,9 ÷ 3,3	17,6	0011587101	Cu Zn PRE-TIN	5000x5	[t]

[t]: Sezione cavo/Wire range/Nennquerschnitt/Section Cable: 0,3+0,3 / 0,5+0,5 - \varnothing Isolante/ \varnothing Insulation/ \varnothing Isolation/ \varnothing Gaine: 1,7+1,7 / 1,9+1,9
[w]: Sezione cavo/Wire range/Nennquerschnitt/Section Cable: 0,35+0,35 - \varnothing Isolante/ \varnothing Insulation/ \varnothing Isolation/ \varnothing Gaine: 1,5+1,5

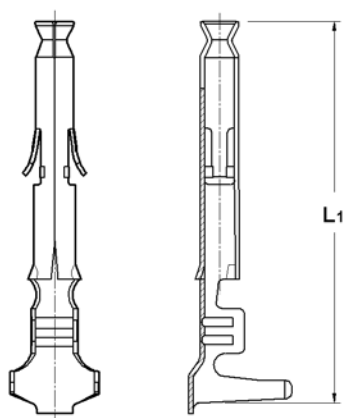

TERMINALI FEMMINA UNIVERSAL

UNIVERSAL SOCKET CONTACTS

UNIVERSAL BUCHSE KONTAKTE

CONTACTS DOUILLE UNIVERSAL

Tab. n° 2

Sezione cavo Wire range Nennquerschnitt Section câble	\varnothing Isolante \varnothing Insulation \varnothing Isolation \varnothing Gaine	L1	Codice Nr. P. N. Art. Nr. Code Nr.	Materiale Material Werkstoff Matiere	Confezione Packing Verpackung Conditionnement	Nota Note Anmerk. Note
0,12 ÷ 0,35	1,2 ÷ 1,8	17	0011588101	Cu Zn PRE-TIN	5000x5	
0,35 ÷ 0,9	1,5 ÷ 2,4	17	0011589101	Cu Zn PRE-TIN	5000x5	[w]
0,5 ÷ 1,3	1,9 ÷ 3,3	17,4	0011590101	Cu Zn PRE-TIN	4800x5	[t]

[t]: Sezione cavo/Wire range/Nennquerschnitt/Section Cable: 0,3+0,3 / 0,5+0,5 - \varnothing Isolante/ \varnothing Insulation/ \varnothing Isolation/ \varnothing Gaine: 1,7+1,7 / 1,9+1,9
[w]: Sezione cavo/Wire range/Nennquerschnitt/Section Cable: 0,35+0,35 - \varnothing Isolante/ \varnothing Insulation/ \varnothing Isolation/ \varnothing Gaine: 1,5+1,5

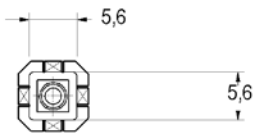

CONNETTORI FEMMINA UNIVERSAL 1 VIA

CAP HOUSINGS UNIVERSAL 1 WAY



AUFNAHMEGEHÄUSE UNIVERSAL 1 POLIG

BOTIERS FEMELLE UNIVERSAL 1 VOIE

Tab. n° 3

Nr. vie Ways No. Polzahl N. Voies	Codice Nr. P. N. Art. Nr. Code Nr.	Materiale Material Werkstoff Matiere	Confezione Packing Verpackung Conditionnement
1	5452048700	PA 66 V-2	15000
	5552048700	PA 66 V-0	
	..52048700	Glow Wire 750° no flame	

9

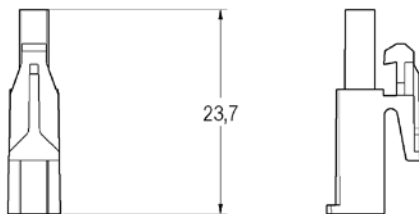

CONNETTORI MASCHIO UNIVERSAL 1 VIA

PLUG HOUSINGS UNIVERSAL 1 WAY

STECKERGEHÄUSE UNIVERSAL 1 POLIG

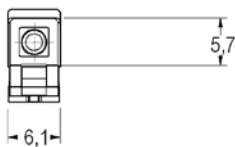

BOTIERS MALE UNIVERSAL 1 VOIE

Tab. n° 4

Nr. vie Ways No. Polzahl N. Voies	Codice Nr. P. N. Art. Nr. Code Nr.	Materiale Material Werkstoff Matiere	Confezione Packing Verpackung Conditionnement
1	5452036700	PA 66 V-2	15000
	5552036700	PA 66 V-0	
	..52036700	Glow Wire 750° no flame	

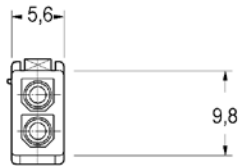

CONNETTORI FEMMINA UNIVERSAL 2 VIE

CAP HOUSINGS UNIVERSAL 2 WAYS



AUFNAHMEGEHÄUSE UNIVERSAL 2-POLIG

BOTIERS FEMELLE UNIVERSAL 2 VOIES

Tab. n°5

Nr. vie Ways No. Polzahl N. Voies	Codice Nr. P. N. Art. Nr. Code Nr.	Materiale Material Werkstoff Matiere	Confezione Packing Verpackung Conditionnement
2	5452049700	PA 66 V-2	10000
	5552049700	PA 66 V-0	
	..52049700	Glow Wire 750° no flame	

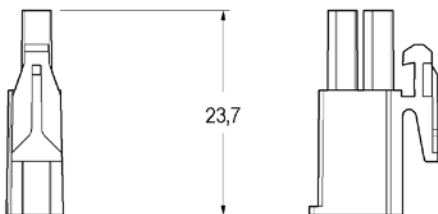

CONNETTORI MASCHIO UNIVERSAL 2 VIE

PLUG HOUSINGS UNIVERSAL 2 WAYS

STECKERGEHÄUSE UNIVERSAL 2-POLIG

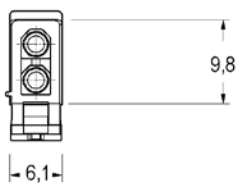

BOTIERS MALE UNIVERSAL 2 VOIES

Tab. n° 6

Nr. vie Ways No. Polzahl N. Voies	Codice Nr. P. N. Art. Nr. Code Nr.	Materiale Material Werkstoff Matiere	Confezione Packing Verpackung Conditionnement
2	5452037700	PA 66 V-2	10000
	5552037700	PA 66 V-0	
	..52037700	Glow Wire 750° no flame	

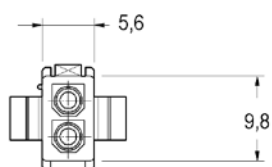

**CONNETTORI FEMMINA UNIVERSAL 2 VIE
CON AGGANCI**

**CAP HOUSINGS UNIVERSAL 2 WAYS
WITH HOOKS**

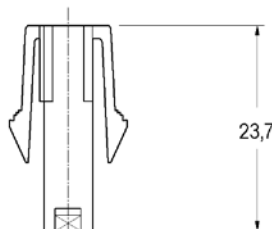

**AUFNAHMEGEHÄUSE UNIVERSAL 2-POLIG
MIT KUPPLUNG**

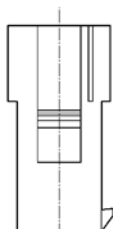

**BOTIERS FEMELLE UNIVERSAL 2 VOIES
AVEC ACCROCHAGE**

Tab. n°7

Nr. vie Ways No. Polzahl N. Voies	Codice Nr. P. N. Art. Nr. Code Nr.	Materiale Material Werkstoff Matiere	Confezione Packing Verpackung Conditionnement
2	5452056700	PA 66 V-2	10000
	5552056700	PA 66 V-0	
	..52056700	Glow Wire 750° no flame	

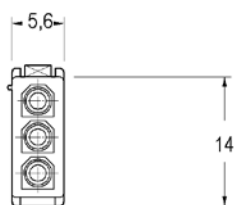

CONNETTORI FEMMINA UNIVERSAL 3 VIE

CAP HOUSINGS UNIVERSAL 3 WAYS

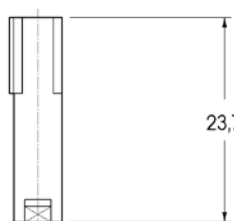

AUFNAHMEGEHÄUSE UNIVERSAL 3-POLIG

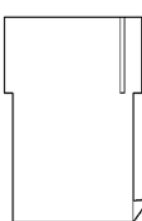

BOTIERS FEMELLE UNIVERSAL 3 VOIES

Tab. n°8

Nr. vie Ways No. Polzahl N. Voies	Codice Nr. P. N. Art. Nr. Code Nr.	Materiale Material Werkstoff Matiere	Confezione Packing Verpackung Conditionnement
3	5452050700	PA 66 V-2	10000
	5552050700	PA 66 V-0	
	..52050700	Glow Wire 750° no flame	

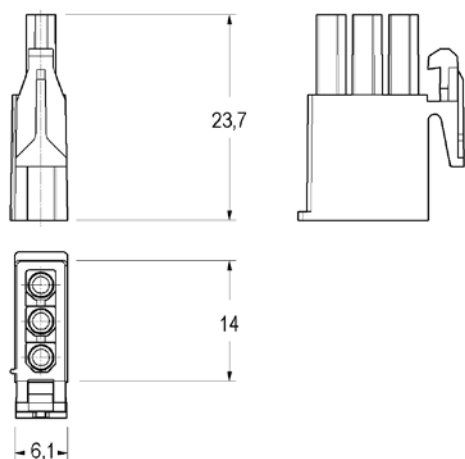

CONNETTORI MASCHIO UNIVERSAL 3 VIE

PLUG HOUSINGS UNIVERSAL 3 WAYS

STECKERGEHÄUSE UNIVERSAL 3-POLIG

BOTIERS MALE UNIVERSAL 3 VOIES

Tab. n° 9

Nr. vie Ways No. Polzahl N. Voies	Codice Nr. P. N. Art. Nr. Code Nr.	Materiale Material Werkstoff Matiere	Confezione Packing Verpackung Conditionnement
3	5452038700	PA 66 V-2	10000
	5552038700	PA 66 V-0	
	..52038700	Glow Wire 750° no flame	

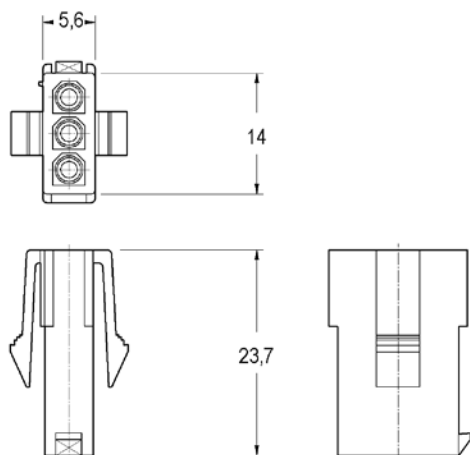

CONNETTORI FEMMINA UNIVERSAL 3 VIE
CON AGGANCI

CAP HOUSINGS UNIVERSAL 3 WAYS
WITH HOOKS

AUFNAHMEGEHÄUSE UNIVERSAL 3-POLIG
MIT KUPPLUNG

BOTIERS FEMELLE UNIVERSAL 3 VOIES
AVEC ACCROCHAGE

Tab. n° 10

Nr. vie Ways No. Polzahl N. Voies	Codice Nr. P. N. Art. Nr. Code Nr.	Materiale Material Werkstoff Matiere	Confezione Packing Verpackung Conditionnement
3	5452057700	PA 66 V-2	10000
	5552057700	PA 66 V-0	
	..52057700	Glow Wire 750° no flame	

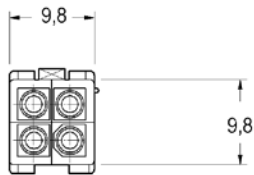

CONNETTORI FEMMINA UNIVERSAL 4 VIE

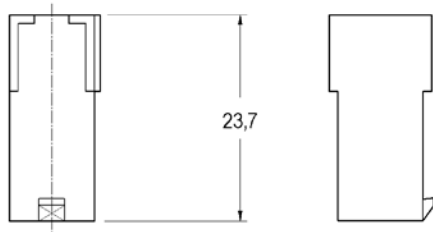

CAP HOUSINGS UNIVERSAL 4 WAYS

AUFNAHMEGEHÄUSE UNIVERSAL 4-POLIG

BOTIERS FEMELLE UNIVERSAL 4 VOIES

Tab. n° 11

Nr. vie Ways No. Polzahl N. Voies	Codice Nr. P. N. Art. Nr. Code Nr.	Materiale Material Werkstoff Matiere	Confezione Packing Verpackung Conditionnement
4	5452051700	PA 66 V-2	10000
	5552051700	PA 66 V-0	
	..52051700	Glow Wire 750° no flame	

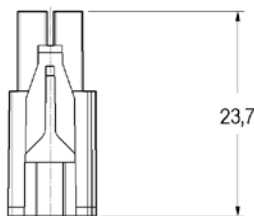

CONNETTORI MASCHIO UNIVERSAL 4 VIE

PLUG HOUSINGS UNIVERSAL 4 WAYS

STECKERGEHÄUSE UNIVERSAL 4-POLIG

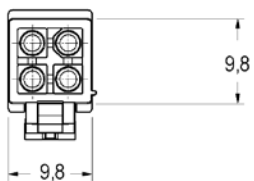

BOTIERS MALE UNIVERSAL 4 VOIES

Tab. n° 12

Nr. vie Ways No. Polzahl N. Voies	Codice Nr. P. N. Art. Nr. Code Nr.	Materiale Material Werkstoff Matiere	Confezione Packing Verpackung Conditionnement
4	5452039700	PA 66 V-2	10000
	5552039700	PA 66 V-0	
	..52039700	Glow Wire 750° no flame	

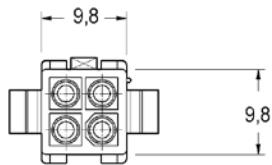

CONNETTORI FEMMINA UNIVERSAL 4 VIE
CON AGGANCI

CAP HOUSINGS UNIVERSAL 4 WAYS
WITH HOOKS

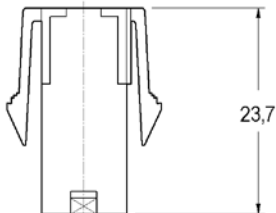

AUFNAHMEGEHÄUSE UNIVERSAL 4-POLIG
MIT KUPPLUNG

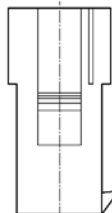

BOTIERS FEMELLE UNIVERSAL 4 VOIES
AVEC ACCROCHAGE

Tab. n° 13

Nr. vie Ways No. Polzahl N. Voies	Codice Nr. P. N. Art. Nr. Code Nr.	Materiale Material Werkstoff Matiere	Confezione Packing Verpackung Conditionnement
4	5452058700	PA 66 V-2	10000
	5552058700	PA 66 V-0	
	..52058700	Glow Wire 750° no flame	

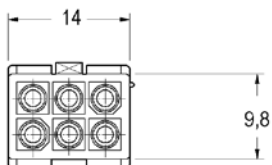

CONNETTORI FEMMINA UNIVERSAL 6 VIE

CAP HOUSINGS UNIVERSAL 6 WAYS

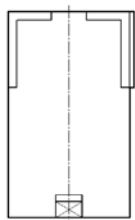

AUFNAHMEGEHÄUSE UNIVERSAL 6-POLIG



BOTIERS FEMELLE UNIVERSAL 6 VOIES

Tab. n° 14

Nr. vie Ways No. Polzahl N. Voies	Codice Nr. P. N. Art. Nr. Code Nr.	Materiale Material Werkstoff Matiere	Confezione Packing Verpackung Conditionnement
6	5452052700	PA 66 V-2	8000
	5552052700	PA 66 V-0	
	..52052700	Glow Wire 750° no flame	

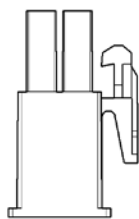
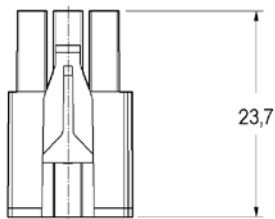

CONNETTORI MASCHIO UNIVERSAL 6 VIE

PLUG HOUSINGS UNIVERSAL 6 WAYS

STECKERGEHÄUSE UNIVERSAL 6-POLIG

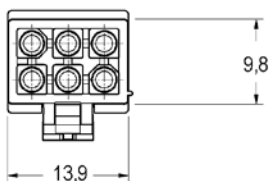

BOTIERS MALE UNIVERSAL 6 VOIES

Tab. n° 15

Nr. vie Ways No. Polzahl N. Voies	Codice Nr. P. N. Art. Nr. Code Nr.	Materiale Material Werkstoff Matiere	Confezione Packing Verpackung Conditionnement
6	5452040700	PA 66 V-2	8000
	5552040700	PA 66 V-0	
	..52040700	Glow Wire 750° no flame	

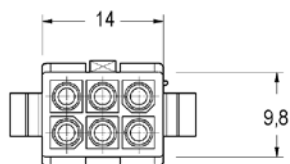

CONNETTORI FEMMINA UNIVERSAL 6 VIE
CON AGGANCI

CAP HOUSINGS UNIVERSAL 6 WAYS
WITH HOOKS

AUFNAHMEGEHÄUSE UNIVERSAL 6-POLIG
MIT KUPPLUNG

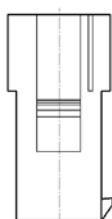
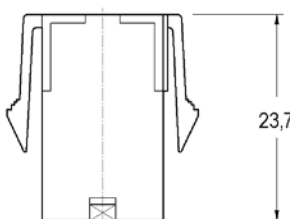

BOTIERS FEMELLE UNIVERSAL 6 VOIES
AVEC ACCROCHAGE

Tab. n° 16

Nr. vie Ways No. Polzahl N. Voies	Codice Nr. P. N. Art. Nr. Code Nr.	Materiale Material Werkstoff Matiere	Confezione Packing Verpackung Conditionnement
6	5452059700	PA 66 V-2	8000
	5552059700	PA 66 V-0	
	..52059700	Glow Wire 750° no flame	

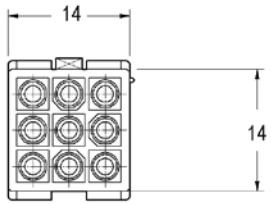

CONNETTORI FEMMINA UNIVERSAL 9 VIE

CAP HOUSINGS UNIVERSAL 9 WAYS

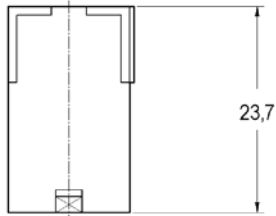

AUFNAHMEGEHÄUSE UNIVERSAL 9-POLIG

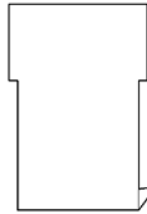

BOTIERS FEMELLE UNIVERSAL 9 VOIES

Tab. n° 17

Nr. vie Ways No. Polzahl N. Voies	Codice Nr. P. N. Art. Nr. Code Nr.	Materiale Material Werkstoff Matiere	Confezione Packing Verpackung Conditionnement
9	5452053700	PA 66 V-2	8000
	5552053700	PA 66 V-0	
	..52053700	Glow Wire 750° no flame	

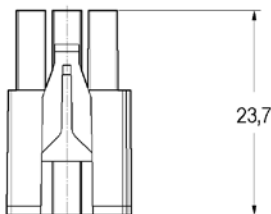

CONNETTORI MASCHIO UNIVERSAL 9 VIE

PLUG HOUSINGS UNIVERSAL 9 WAYS

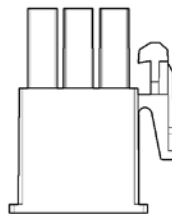

STECKERGEHÄUSE UNIVERSAL 9-POLIG

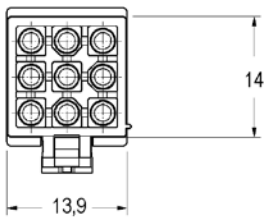

BOTIERS MALE UNIVERSAL 9 VOIES

Tab. n° 18

Nr. vie Ways No. Polzahl N. Voies	Codice Nr. P. N. Art. Nr. Code Nr.	Materiale Material Werkstoff Matiere	Confezione Packing Verpackung Conditionnement
9	5452041700	PA 66 V-2	8000
	5552041700	PA 66 V-0	
	..52041700	Glow Wire 750° no flame	

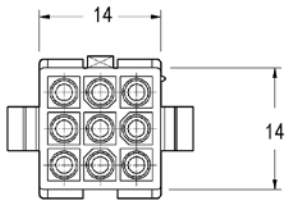

**CONNETTORI FEMMINA UNIVERSAL 9 VIE
CON AGGANCI**

**CAP HOUSINGS UNIVERSAL 9 WAYS
WITH HOOKS**

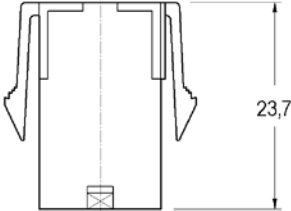

**AUFNAHMEGEHÄUSE UNIVERSAL 9-POLIG
MIT KUPPLUNG**

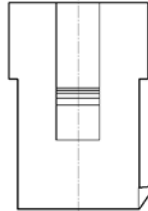

**BOTIERS FEMELLE UNIVERSAL 9 VOIES
AVEC ACCROCHAGE**

Tab. n° 19

Nr. vie Ways No. Polzahl N. Voies	Codice Nr. P. N. Art. Nr. Code Nr.	Materiale Material Werkstoff Matiere	Confezione Packing Verpackung Conditionnement
9	5452060700	PA 66 V-2	8000
	5552060700	PA 66 V-0	
	..52060700	Glow Wire 750° no flame	

9

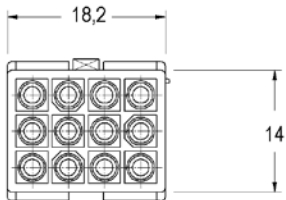

CONNETTORI FEMMINA UNIVERSAL 12 VIE

CAP HOUSINGS UNIVERSAL 12 WAYS

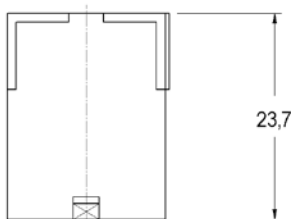

AUFNAHMEGEHÄUSE UNIVERSAL 12-POLIG

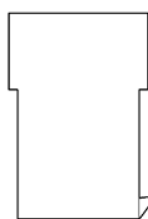

BOTIERS FEMELLE UNIVERSAL 12 VOIES

Tab. n° 20

Nr. vie Ways No. Polzahl N. Voies	Codice Nr. P. N. Art. Nr. Code Nr.	Materiale Material Werkstoff Matiere	Confezione Packing Verpackung Conditionnement
12	5452054700	PA 66 V-2	5000
	5552054700	PA 66 V-0	
	..52054700	Glow Wire 750° no flame	

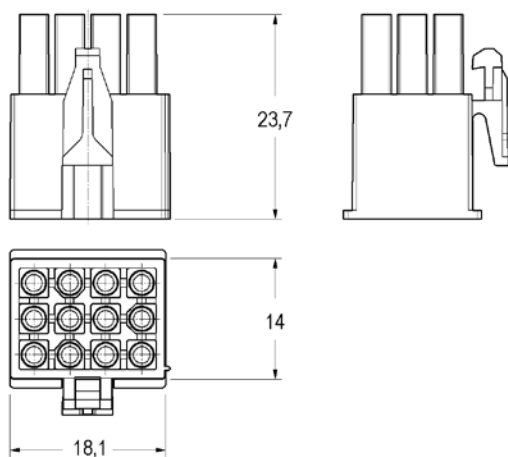

CONNETTORI MASCHIO UNIVERSAL 12 VIE

PLUG HOUSINGS UNIVERSAL 12 WAYS

STECKERGEHÄUSE UNIVERSAL 12-POLIG

BOTIERS MALE UNIVERSAL 12 VOIES

Tab. n° 21

Nr. vie Ways No. Polzahl N. Voies	Codice Nr. P. N. Art. Nr. Code Nr.	Materiale Material Werkstoff Matiere	Confezione Packing Verpackung Conditionnement
12	5452042700	PA 66 V-2	5000
	5552042700	PA 66 V-0	
	..52042700	Glow Wire 750° no flame	

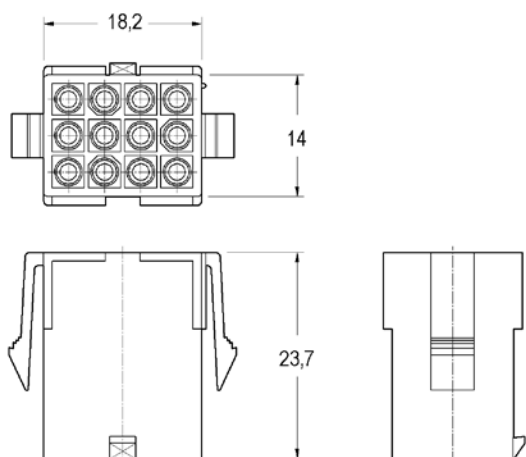

CONNETTORI FEMMINA UNIVERSAL 12 VIE
CON AGGANCI

CAP HOUSINGS UNIVERSAL 12 WAYS
WITH HOOKS

AUFNAHMEGEHÄUSE UNIVERSAL 12-POLIG
MIT KUPPLUNG

BOTIERS FEMELLE UNIVERSAL 12 VOIES
AVEC ACCROCHAGE

Tab. n° 22

Nr. vie Ways No. Polzahl N. Voies	Codice Nr. P. N. Art. Nr. Code Nr.	Materiale Material Werkstoff Matiere	Confezione Packing Verpackung Conditionnement
12	5452061700	PA 66 V-2	5000
	5552061700	PA 66 V-0	
	..52061700	Glow Wire 750° no flame	

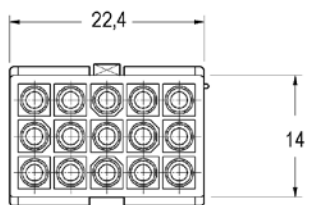

CONNETTORI FEMMINA UNIVERSAL 15 VIE

CAP HOUSINGS UNIVERSAL 15 WAYS

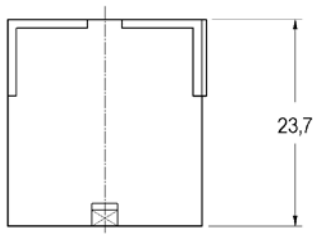

AUFNAHMEGEHÄUSE UNIVERSAL 15-POLIG

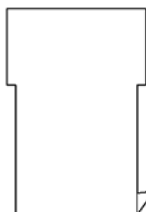

BOTIERS FEMELLE UNIVERSAL 15 VOIES

Tab. n° 23

Nr. vie Ways No. Polzahl N. Voies	Codice Nr. P. N. Art. Nr. Code Nr.	Materiale Material Werkstoff Matiere	Confezione Packing Verpackung Conditionnement
15	5452055700	PA 66 V-2	5000
	5552055700	PA 66 V-0	
	..52055700	Glow Wire 750° no flame	

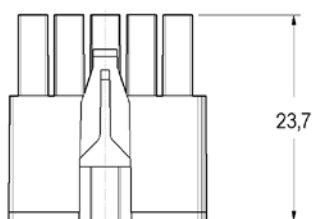

CONNETTORI MASCHIO UNIVERSAL 15 VIE

PLUG HOUSINGS UNIVERSAL 15 WAYS

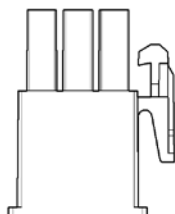

STECKERGEHÄUSE UNIVERSAL 15-POLIG

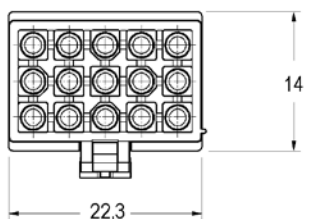

BOTIERS MALE UNIVERSAL 15 VOIES

Tab. n° 24

Nr. vie Ways No. Polzahl N. Voies	Codice Nr. P. N. Art. Nr. Code Nr.	Materiale Material Werkstoff Matiere	Confezione Packing Verpackung Conditionnement
15	5452043700	PA 66 V-2	5000
	5552043700	PA 66 V-0	
	..52043700	Glow Wire 750° no flame	

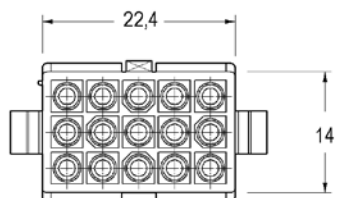

CONNETTORI FEMMINA UNIVERSAL 15 VIE
CON AGGANCI

CAP HOUSINGS UNIVERSAL 15 WAYS
WITH HOOKS

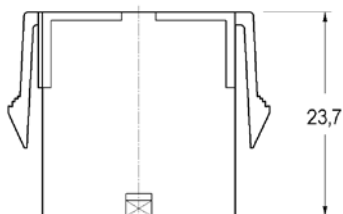

AUFNAHMEGEHÄUSE UNIVERSAL 15-POLIG
MIT KUPPLUNG

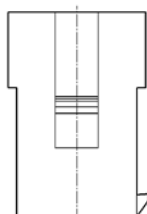

BOTIERS FEMELLE UNIVERSAL 15 VOIES
AVEC ACCROCHAGE

Tab. n° 25

Nr. vie Ways No. Polzahl N. Voies	Codice Nr. P. N. Art. Nr. Code Nr.	Materiale Material Werkstoff Matiere	Confezione Packing Verpackung Conditionnement
15	5452062700	PA 66 V-2	5000
	5552062700	PA 66 V-0	
	..52062700	Glow Wire 750° no flame	

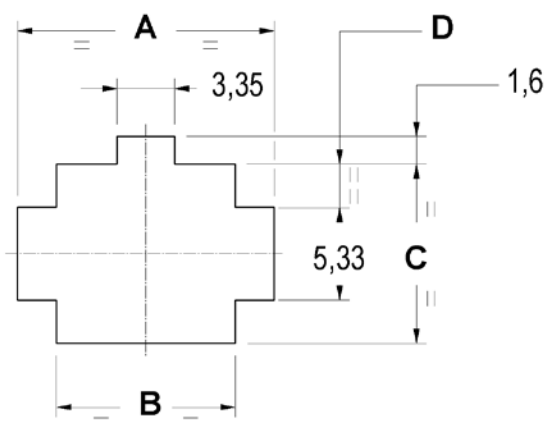

DIMA DI FORATURA
PER CONNETTORI FEMMINA UNIVERSAL
CON AGGANCI

HOUSING PANEL CUTOUT
FOR CAP HOUSINGS UNIVERSAL
WITH HOOKS

MONTAGEAUSCHNITT FÜR GEHÄUSE
FÜR AUFNAHMEGEHÄUSE UNIVERSAL
MIT KUPPLUNG

DECOUPE DU PANNEAU
POUR BOITIERS FEMELLE UNIVERSAL
AVEC ACCROCHAGE

Nr. vie Ways No. Polzahl N. Voies	A	B	C	D	Spessore pannello Panel thickness Dicke von Brett Epaisseur du panneau
2	10,7	6,2	2,5	10,3	0,8 ÷ 2
3	10,7	6,2	4,6	14,6	0,8 ÷ 2
4	14,9	10,4	2,5	10,3	0,8 ÷ 2
6	19,1	14,6	2,5	10,3	0,8 ÷ 2
9	19,1	14,6	4,6	14,6	0,8 ÷ 2
12	23,3	18,7	4,6	14,6	0,8 ÷ 2
15	27,4	22,9	4,6	14,6	0,8 ÷ 2

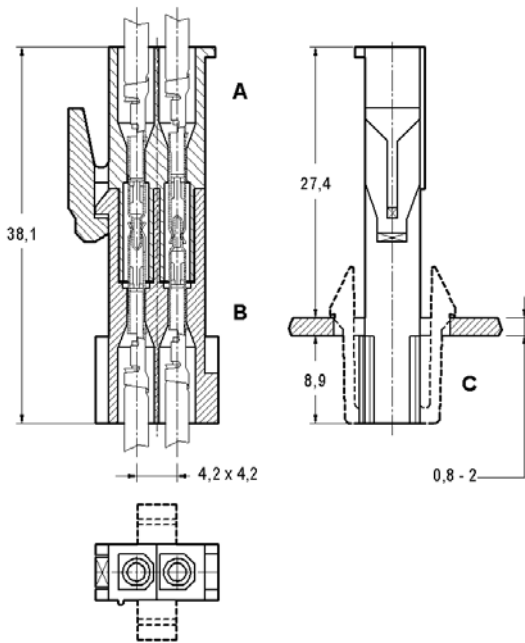
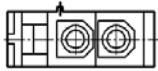

Inar-Minilock
ESEMPIO D'APPLICAZIONE

Inar-Minilock
EXAMPLE OF APPLIANCES

Inar-Minilock
VERWENDUNGBEISIEL

Inar-Minilock
EXEMPLE D'APPLICATION

A - Connettori maschio - Plug housings - Steckergehäuse - Boitiers male

B - Connettori femmina - Cap housings - Aufnahmegehäuse - Boitiers femelle

C - Connettori femmina con agganci - Cap housings with hooks - Aufnahmegehäuse mit kupplung - Boitiersfemelle avec accrochage

Per gli Estrattori della Serie INAR-MINILOCK UNIVERSAL, fare riferimento alle "Attrezzature Manuali" della Sezione "M".

For the Extractors of INAR-MINILOCK UNIVERSAL Series, please referring to "Hand Tools" in Section "M"

